

# Marvin K. Peterson Library

Katie + Hannah

Fall 2021

Studio V

# Concept Statement

The University of New Haven is a growing university on the outskirts of downtown New Haven. The Peterson Library is located at the heart of the University in the academic quad. Influencing the design around the symbolic elements of the elm trees, and architectural planning of the city of New Haven will tie the library back to the city roots. Traditionally a library is aimed to be the main intellectual hub on college campuses. However, the Peterson Library has not been designed to support its growing population since it was built in 1970. Incorporating an open floor plan, open seating options, an updated café, and more study rooms for students will help this library better accommodate the students' academic needs. This design will allow students to grow and achieve academically and support this growing university.

# User research

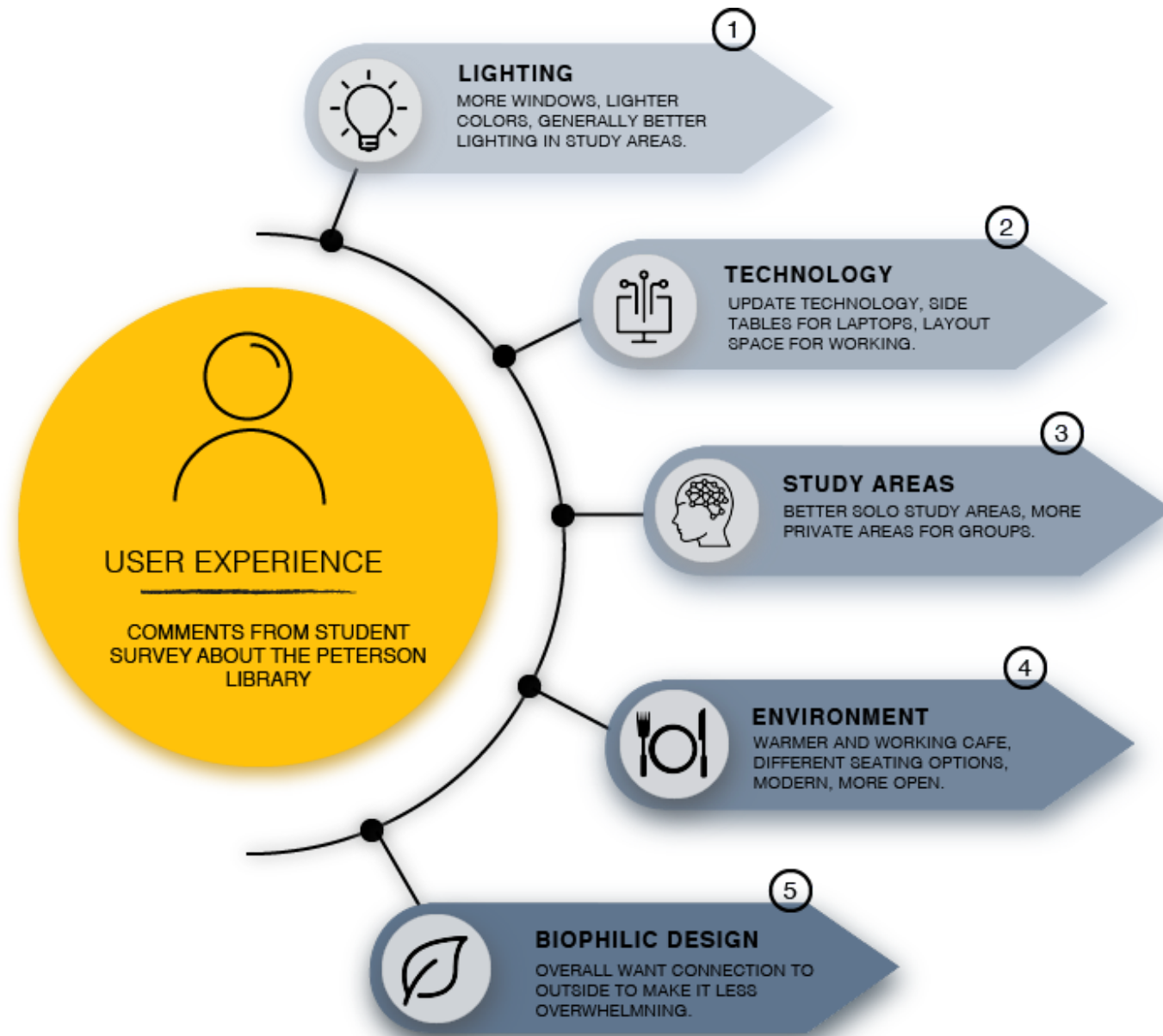

- Sports Management
- Fire Science
- National security
- Finance
- Communication
- Psychology
- Interior Design
- Forensic Science
- Cybersecurity
- Criminal Justice
- Business Management

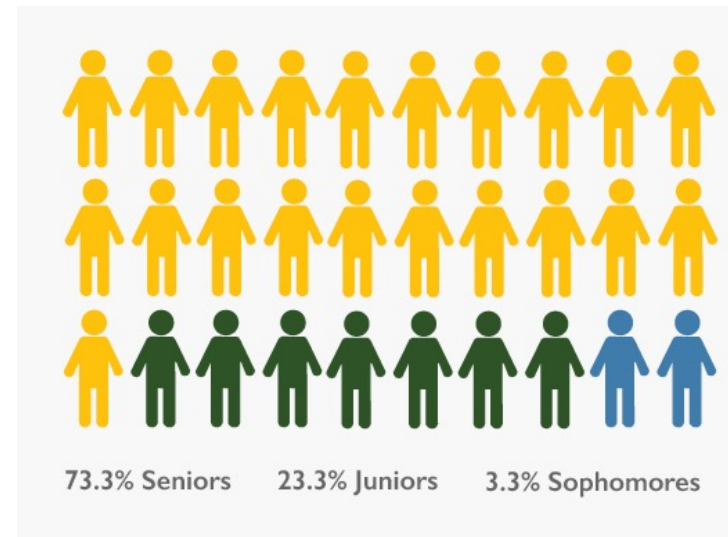

Lower Floor

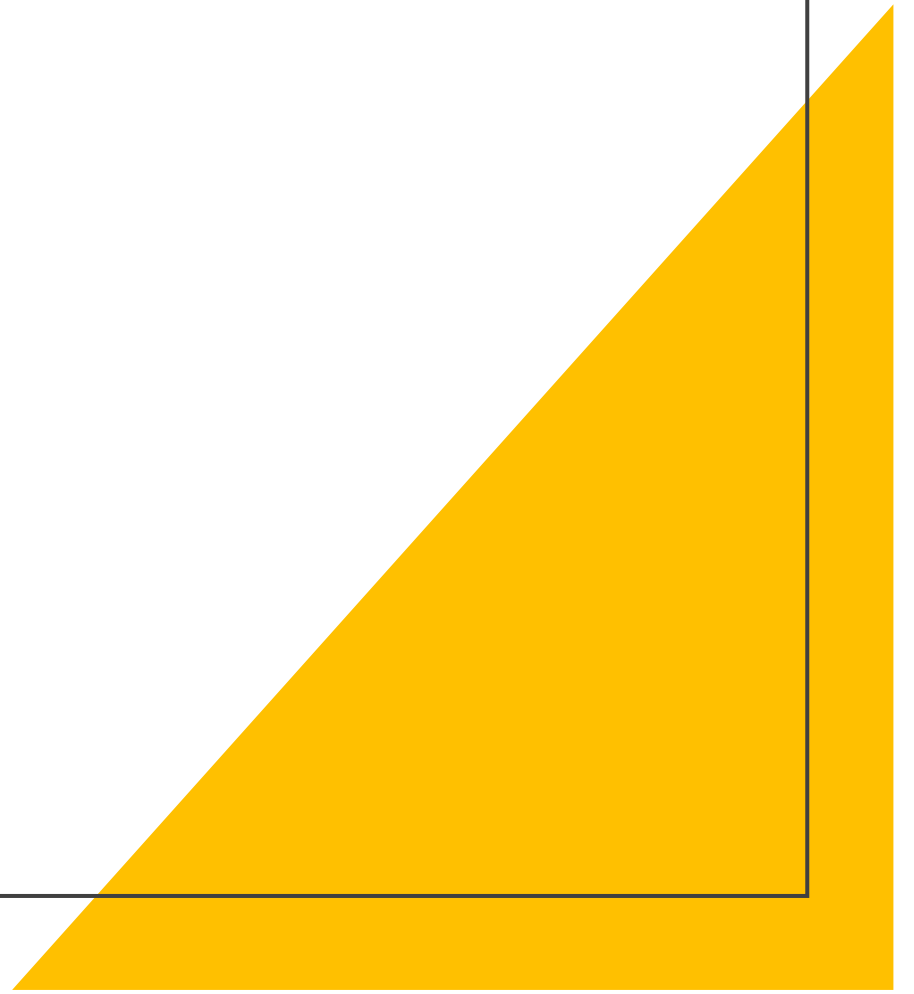

# Furniture Plan

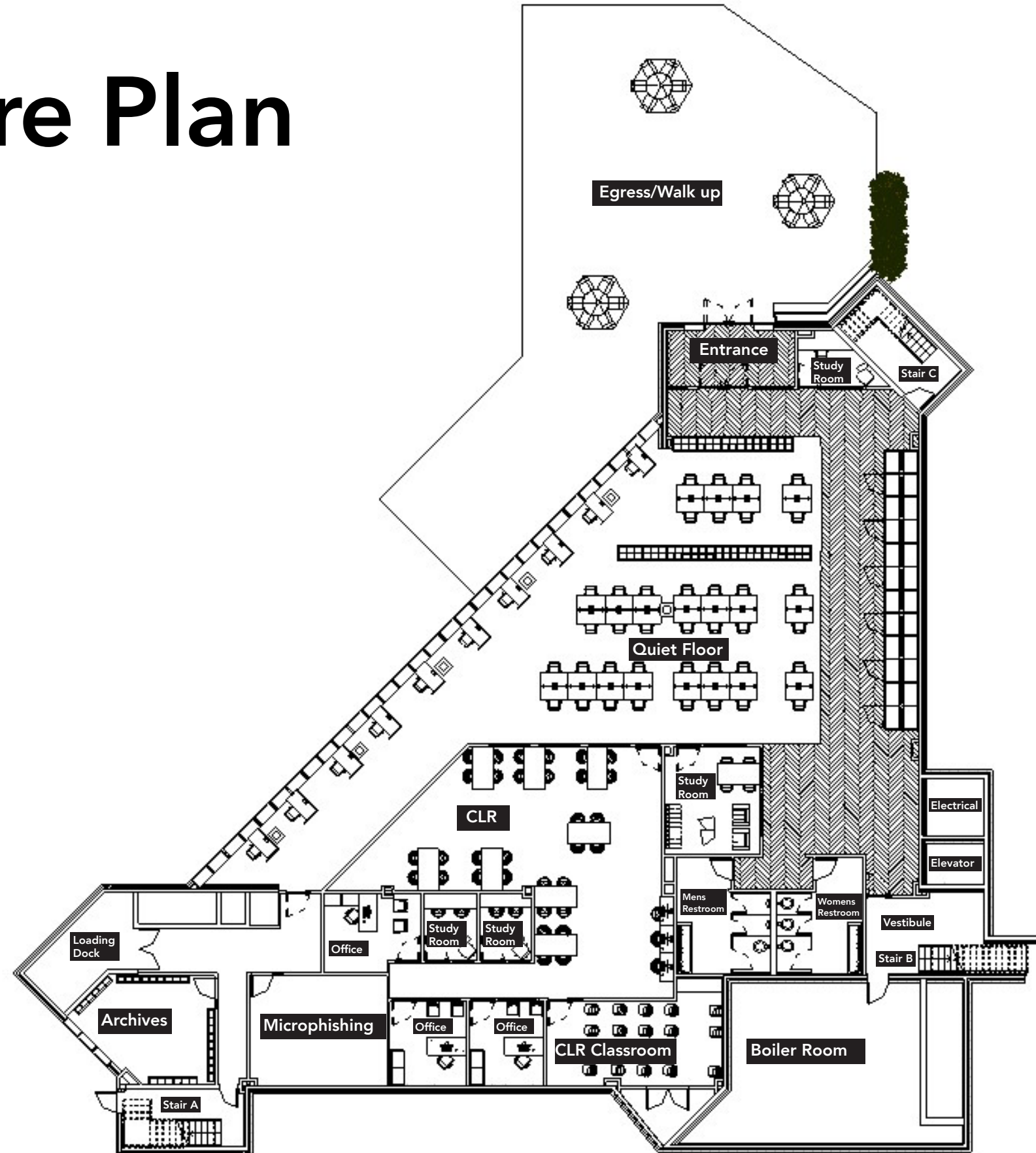

University of New Haven  
**Marvin K. Peterson Library**

Lower Level  
Furniture plan

Fall 2021 Studio V

Floor Plan

# A.1

A1

LOWER-LEVEL FURNITURE PLAN

NTS

# Floor Pattern Plan

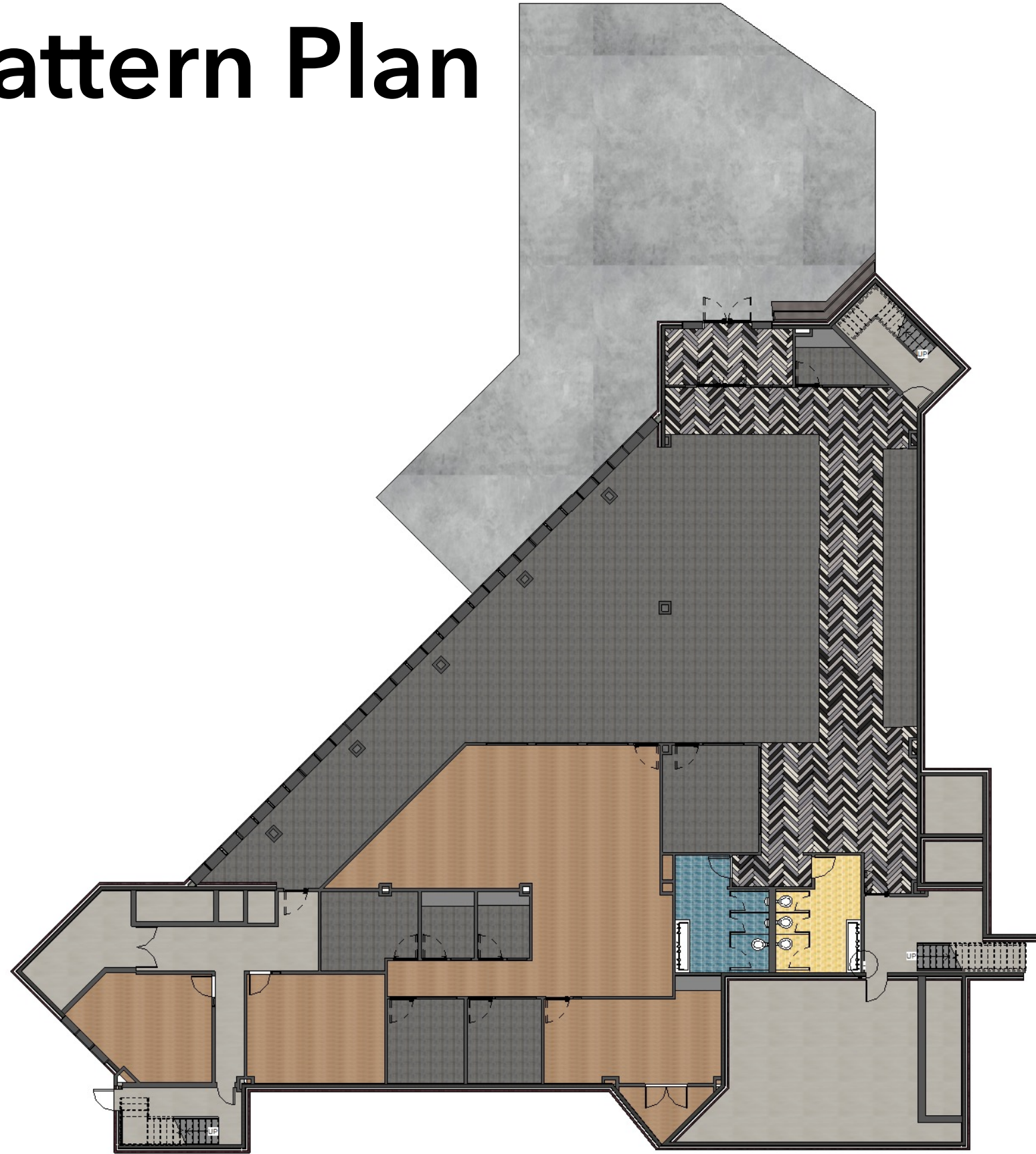

A2

LOWER-LEVEL FLOOR PATTERN PLAN

NTS

# Exterior Rendering



University of New Haven  
**Marvin K. Peterson Library**

Second Entrance  
View

Fall 2021 Studio V

Rendering

P.1

P1

EXTERIOR SECOND ENTRANCE FROM PARKING LOT PERSPECTIVE

NTS

# Quiet Floor Rendering



University of New Haven  
**Marvin K. Peterson Library**

Quiet Floor with  
Exterior Window View

Fall 2021 Studio V

Rendering

P.2

P2 QUIET FLOOR PERSPECTIVE

NTS



# Quiet Floor Finishes

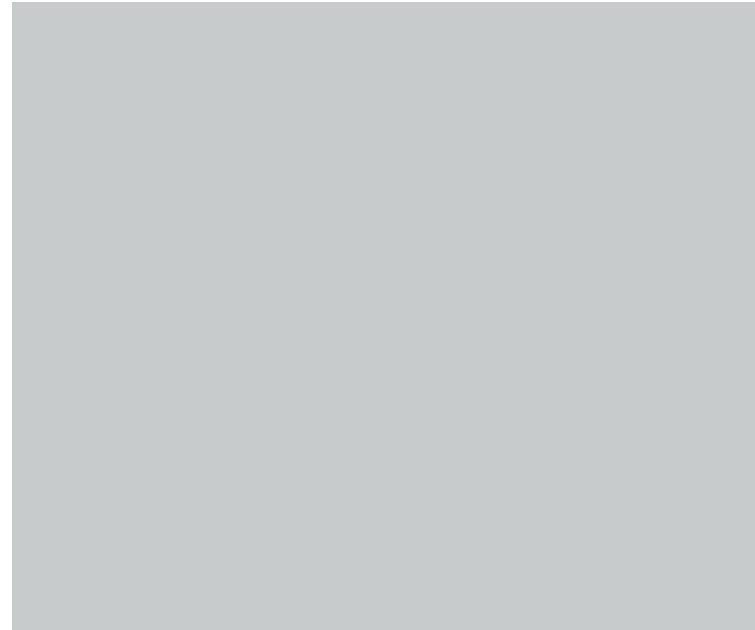

*Wall Paint*



*Carpet Tile*



*Baseboard*



*Herringbone Floor*

# Quiet floor



Library Stacks

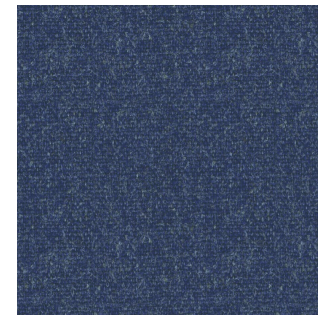

Felt Upholstery

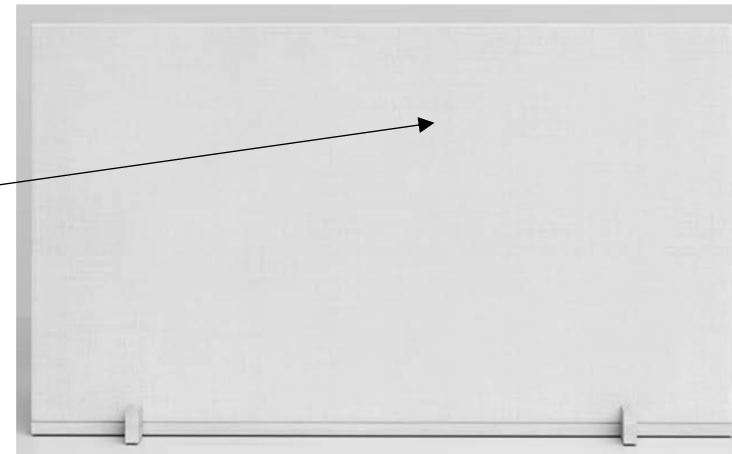

Acoustics: Table Privacy panel



Laminate



Power Desk



Metal

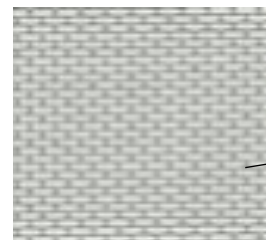

Mesh



Task Chair



Metal

# CLR Finishes

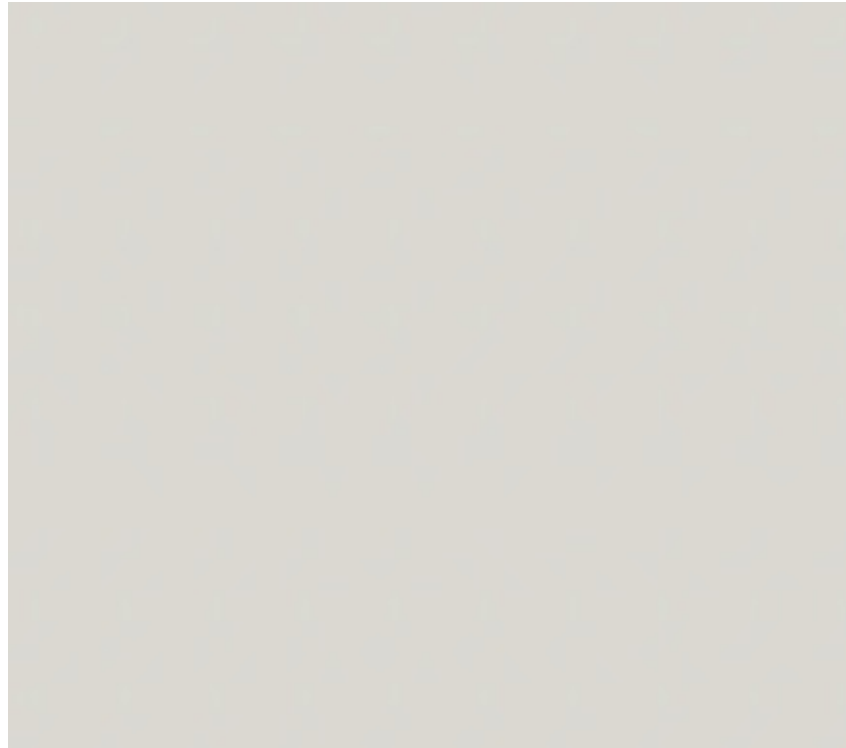

*Wall Paint*



*Baseboard*

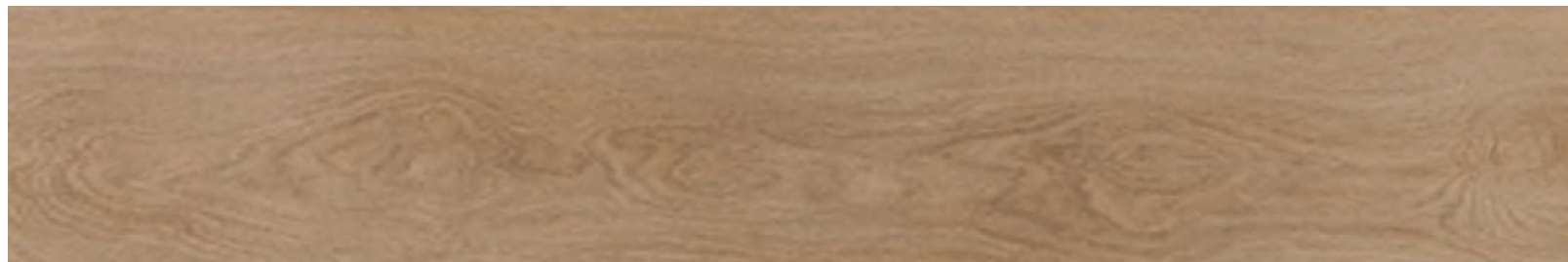

*Porcelain Flooring*

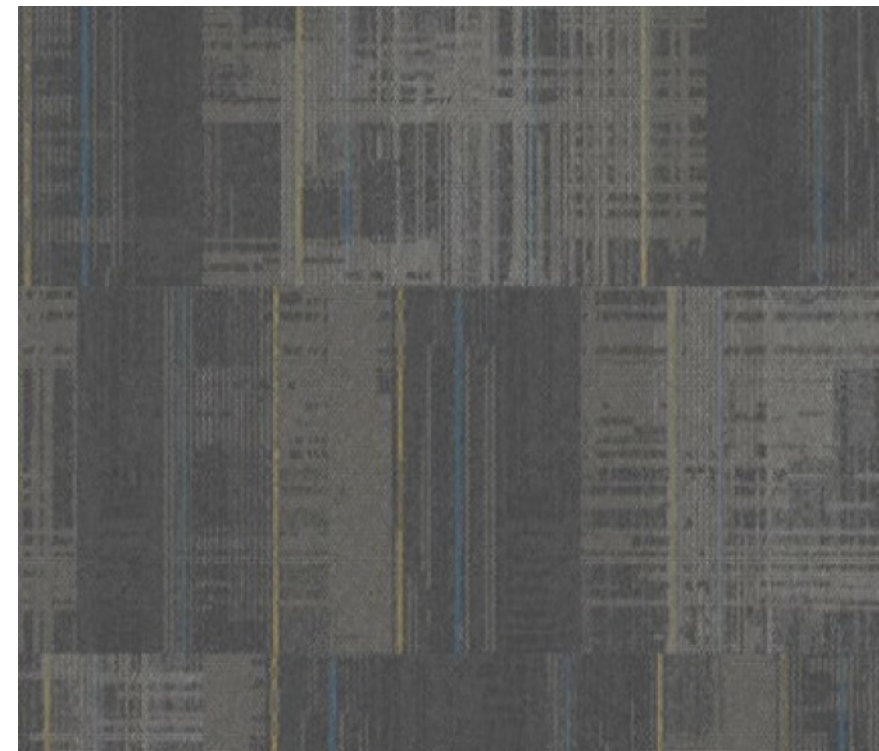

*Carpet Tile*

# Center for Learning Resources



Power Table



Power Table



Task Chair

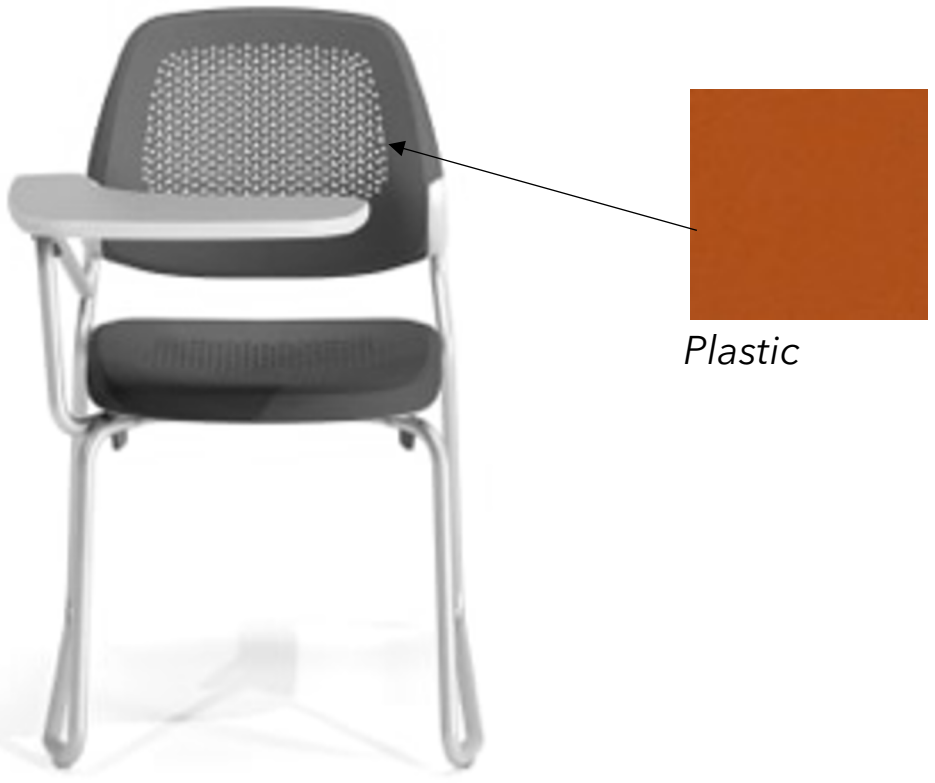

Task Chair

# CLR- Study rooms + offices



Systems Furniture: Office Desk

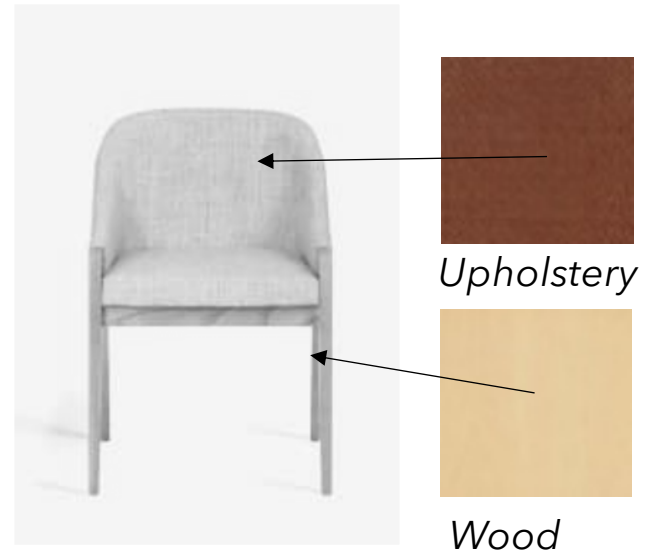

Side Chair

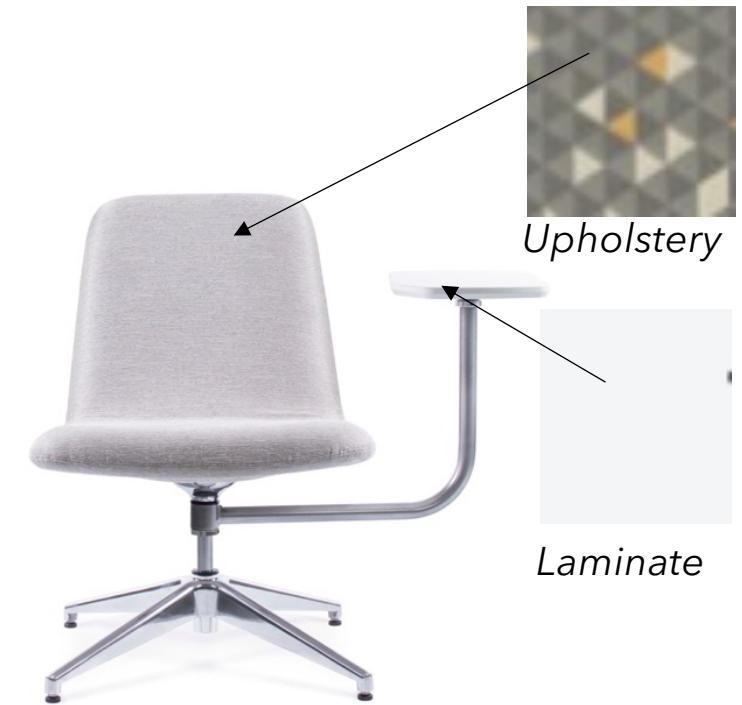

Lounge chair with tablet arm

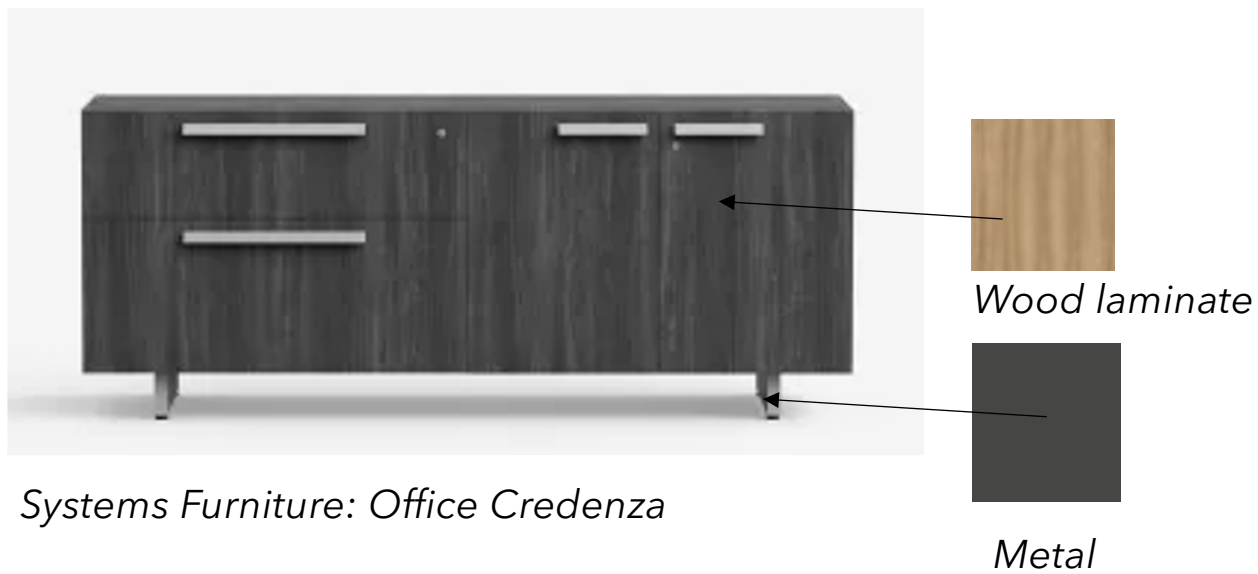

Systems Furniture: Office Credenza

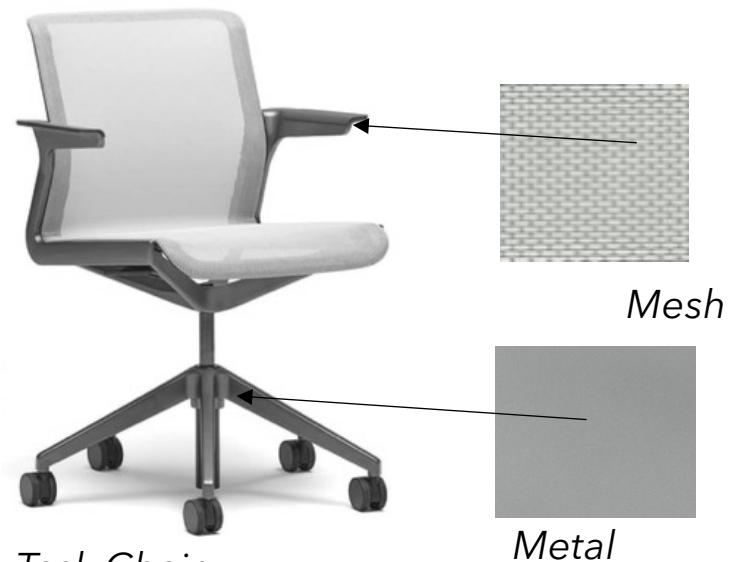

Task Chair

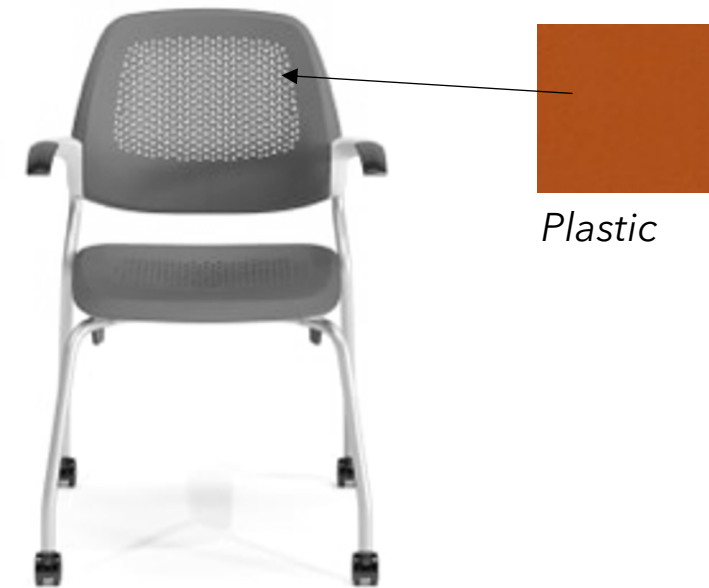

Task Chair

Center for Learning Resources study Rooms and offices Furniture.

Fall 2021 Studio V

Furniture

# FR.3

# Study Room Finishes



*Wall Paint*



*Baseboard*

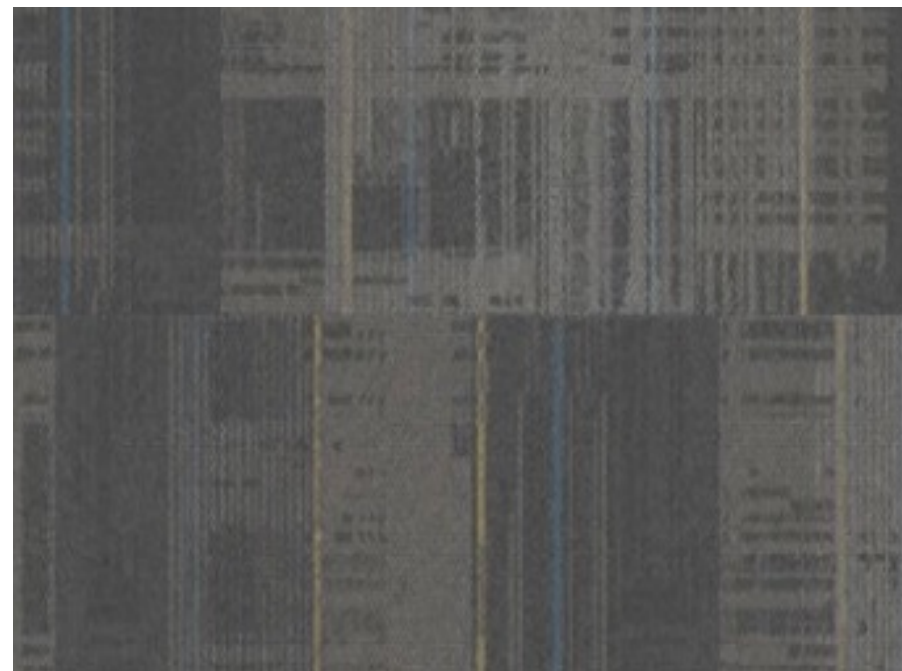

*Carpet*

# Study Rooms



Study Pod



Laminate

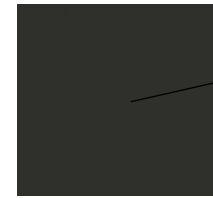

Metal

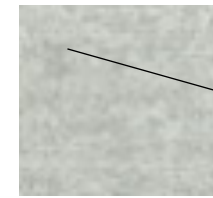

Upholstery



Metal



Power Table



Lounge: Armless Sofa



Upholstery



Metal



Lounge: Club Chair

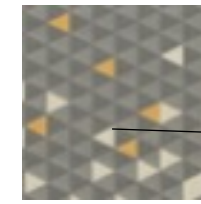

Upholstery



Laminate



Lounge chair with tablet arm

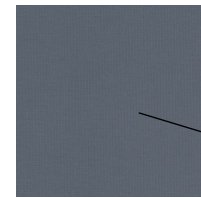

Upholstery

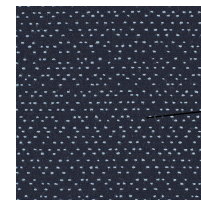

Upholstery

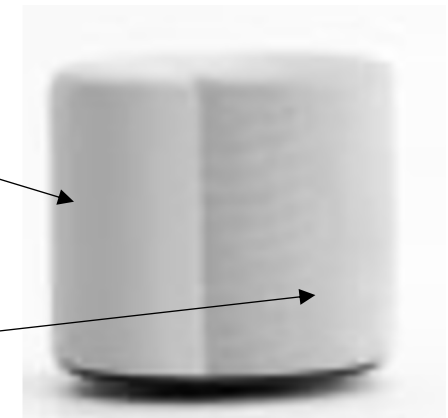

Side Seating

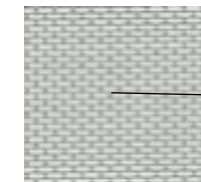

Mesh

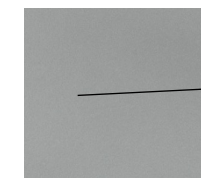

Metal



Task Chair

Main Floor

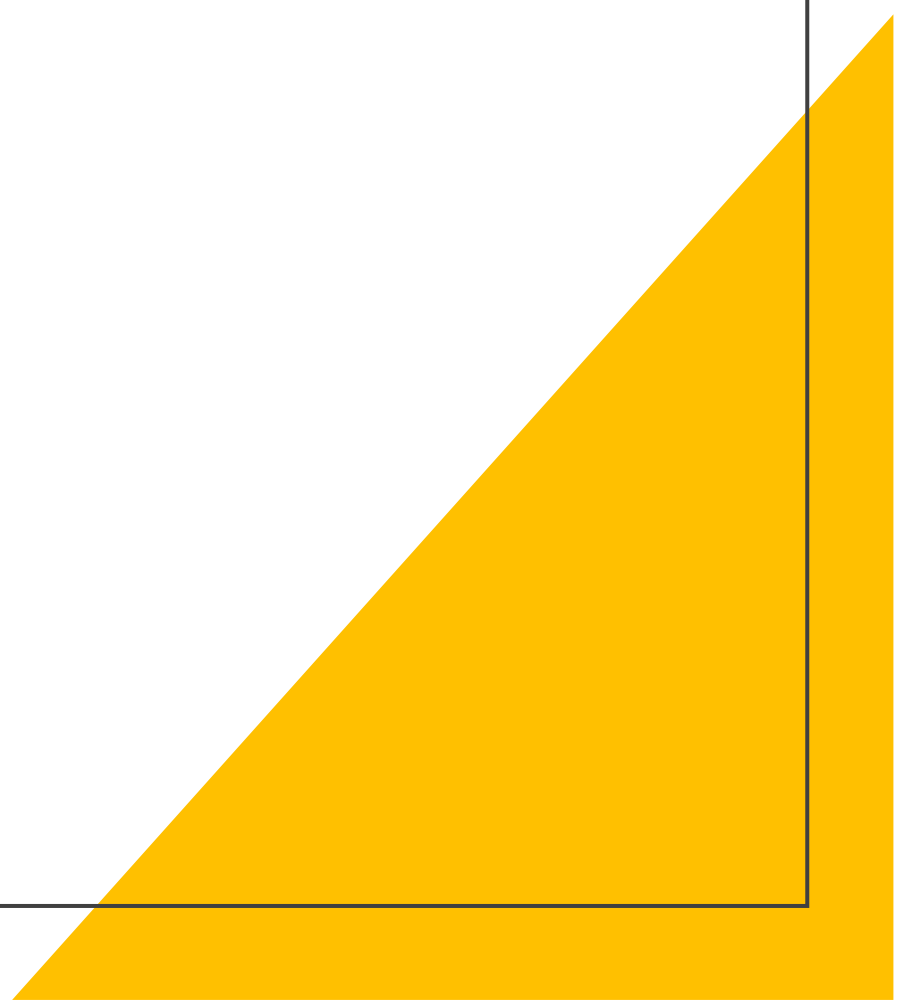



# Furniture Plan

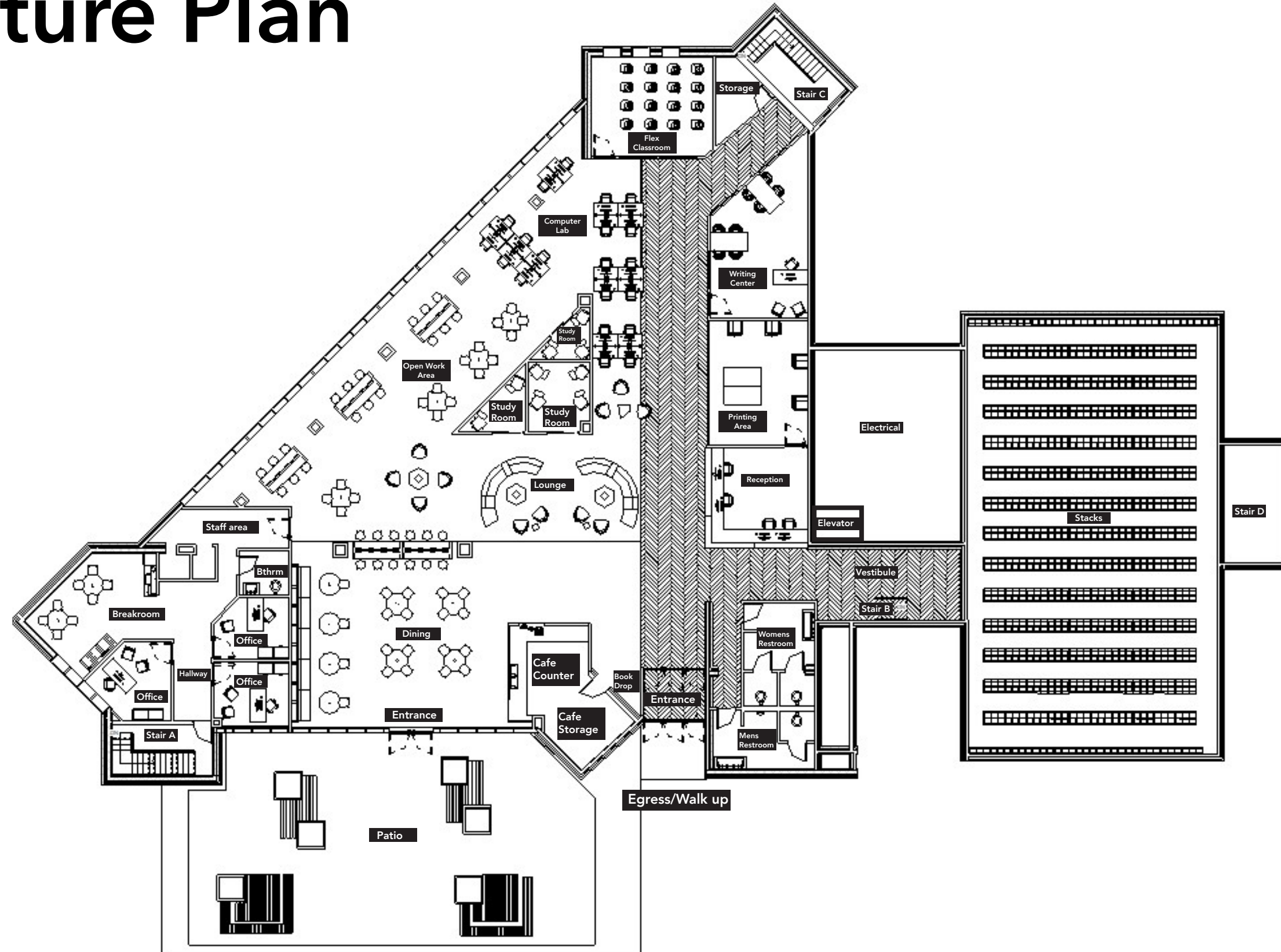

University of New Haven  
**Marvin K. Peterson Library**

Main Floor Furniture Plan

Fall 2021 Studio V

Floor Plan

A.3

A3 MAIN LEVEL FURNITURE PLAN

NTS

# Floor Pattern Plan



# Reception Rendering

kw+hr



University of New Haven  
**Marvin K. Peterson Library**

Main Floor Reception  
View.

Fall 2021 Studio V

Rendering

P3

RECEPTION PERSPECTIVE

NTS

P.3

# Cafe Rendering

kw+hr



University of New Haven  
**Marvin K. Peterson Library**

Café + Dining view.

Fall 2021 Studio V

Rendering

P4

Café + Dining Perspective

NTS

P.4

# Outdoor Patio Rendering

kw+hr

University of New Haven  
**Marvin K. Peterson Library**



Outdoor Patio View

Fall 2021 Studio V

Rendering

P3

Outdoor Patio Perspective

NTS

P.5

# Reception Finishes



Wall Detail



Herringbone Floor



Quartz Countertops



Concrete Desk



# Cafe Finishes

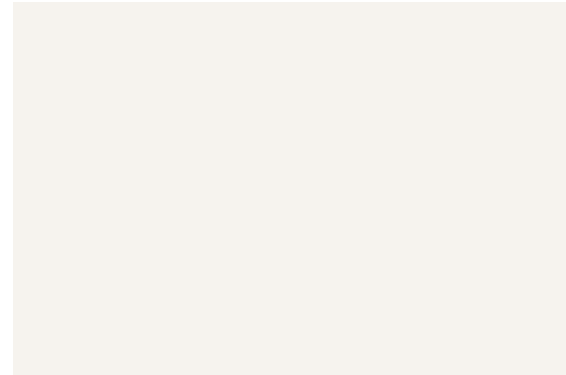

*Wall Paint*



*Quartz Countertops*

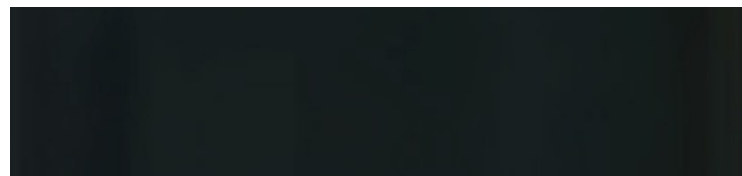

*Base Cabinets*



*Baseboard*

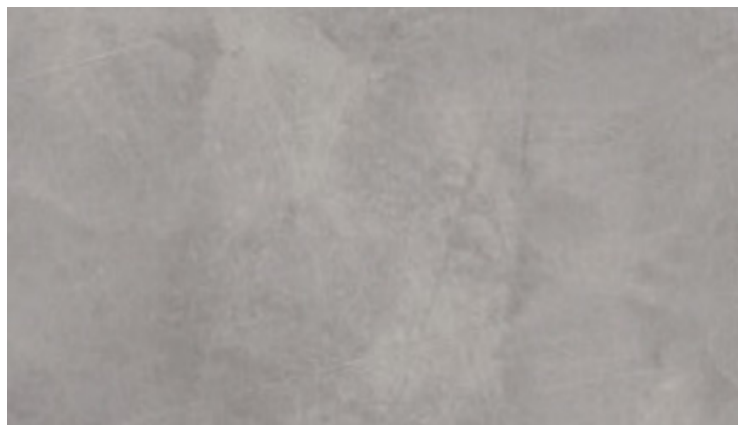

*LVT Tile*

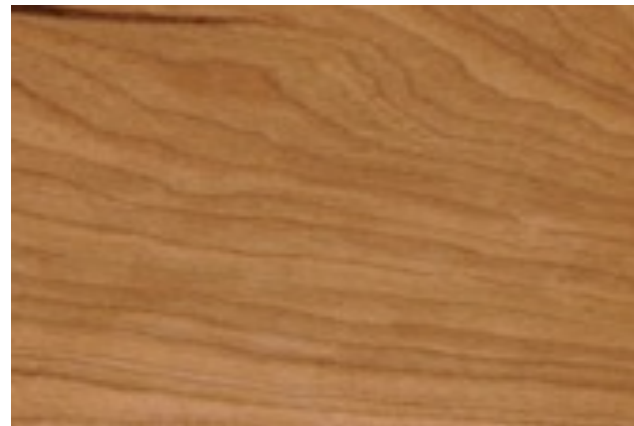

*[Built in] Wood finish*

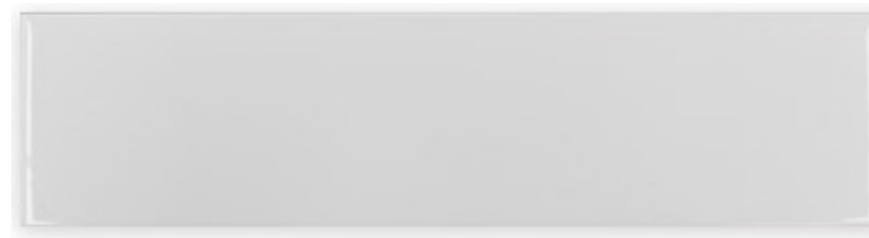

*[Built in] Wall tile*

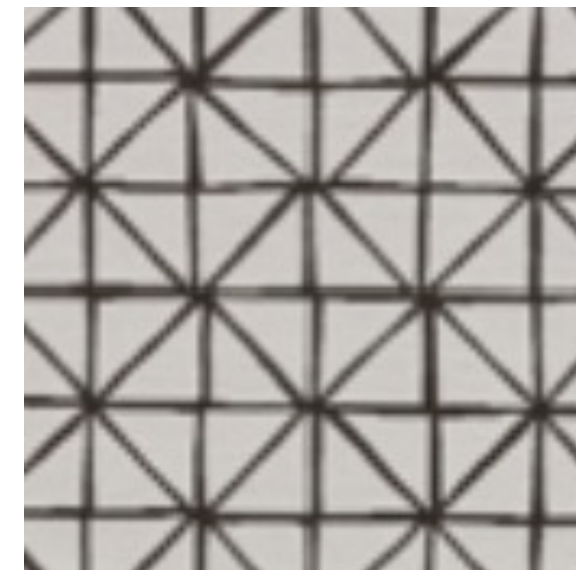

*[Built in] Booth Textile*

# Café



*Collaborative table*



*Power Table*



*Café Chair*



*Café Barstool*



# Social Lounge Finishes

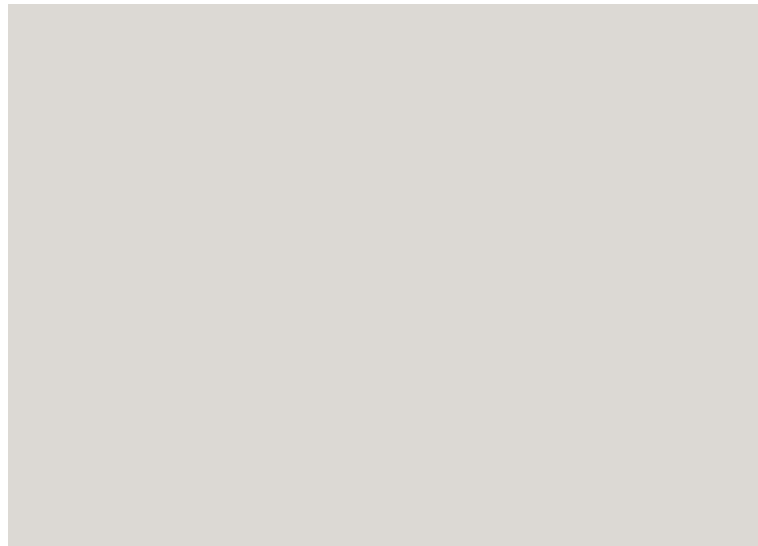

Wall Paint



Baseboard



Carpet Tile



Herringbone Floor

# Social Lounge



Upholstery



Modular lounge seating



Side Table

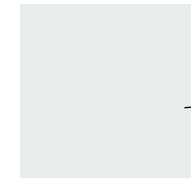

Laminate



Wood

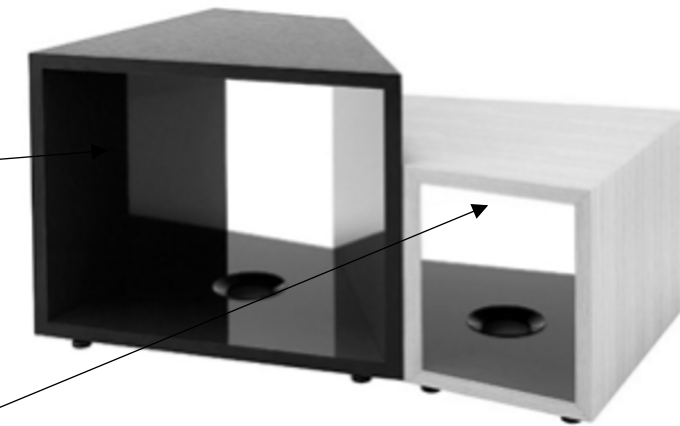

Coffee Table



Upholstery

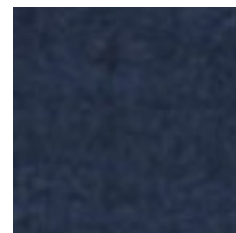

Upholstery

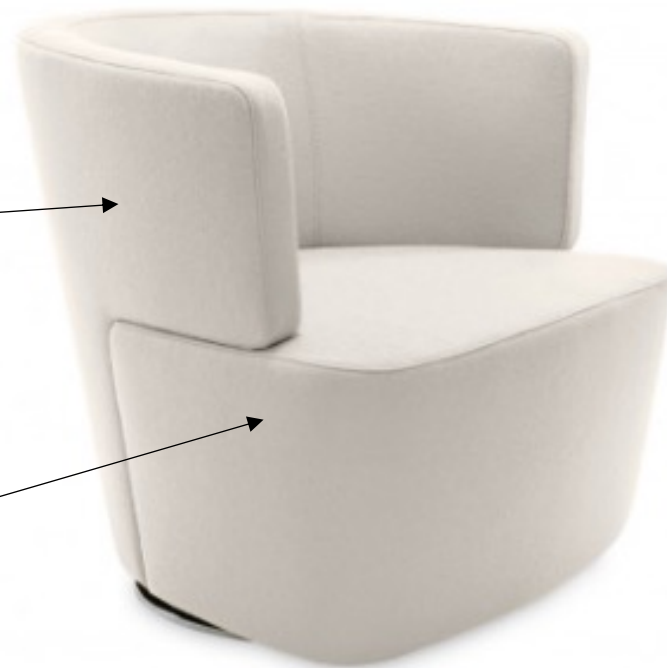

Swivel Chair



Coffee Table

# Study Rooms + Open Work Area Finishes



*Wall Paint*

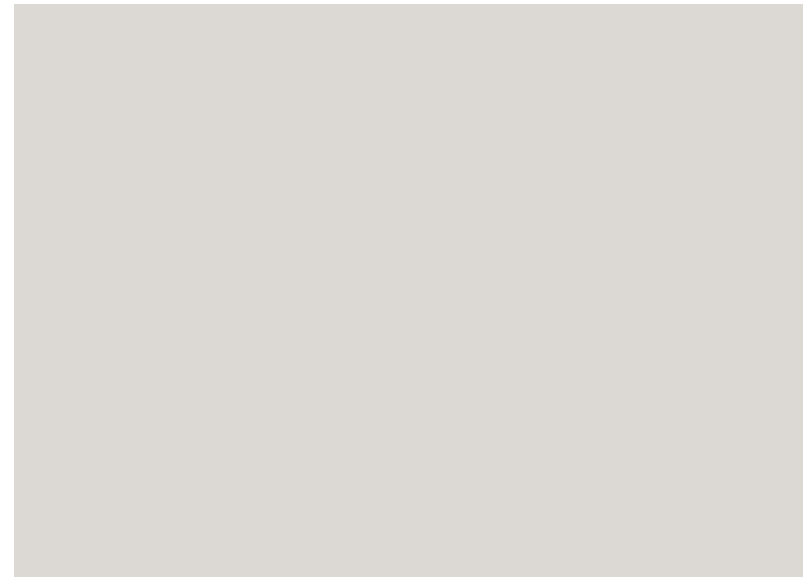

*Wall Paint*



*Baseboard*



*Baseboard*



*Carpet Tile*



*Carpet Tile*

# Open Work Area + Study Room



Collaborative table



Felt Upholstery

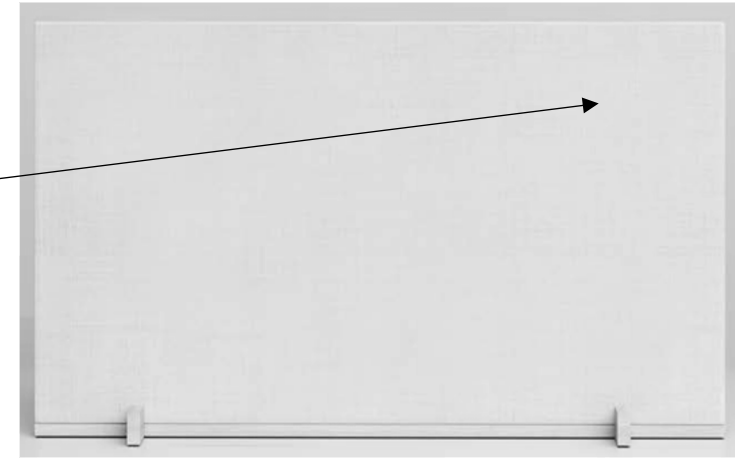

Acoustics: Table Privacy panel

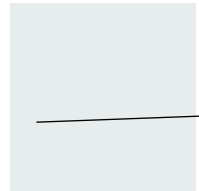

Glass



Wood



Worktable



Laminate



Metal



Power Table

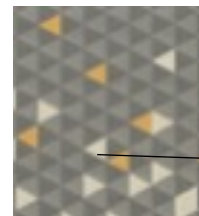

Upholstery



Laminate



Lounge chair with tablet arm - study rooms

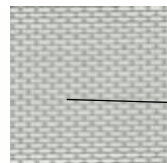

Mesh

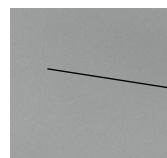

Metal



Task Chair



Work Chair



Work Barstool

# Writing Center Finishes

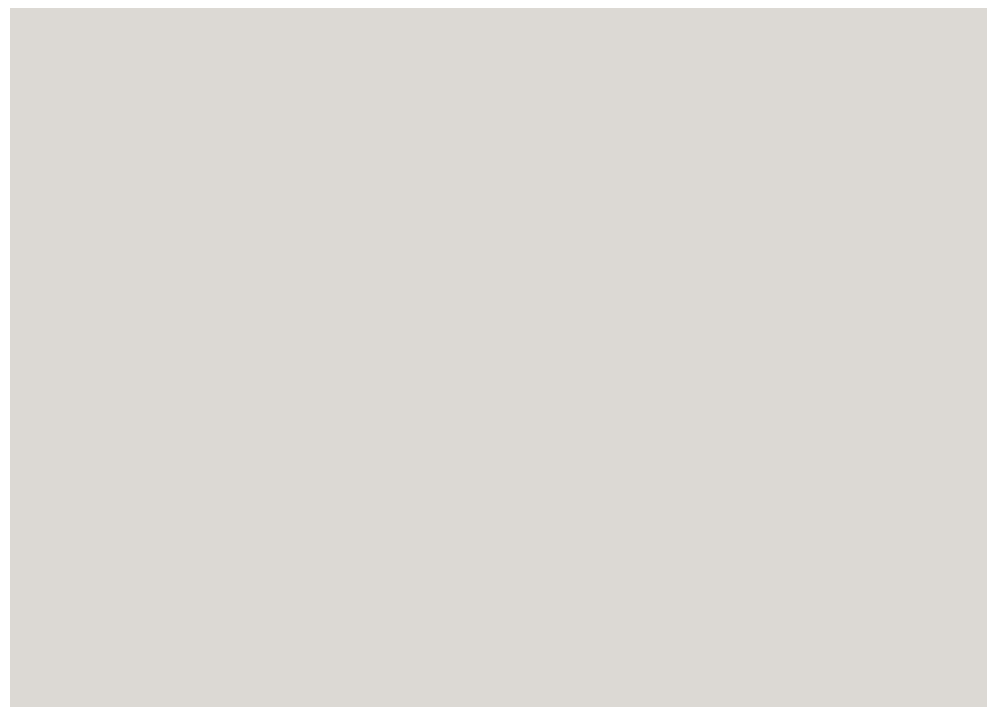

*Wall Paint*



*Baseboard*

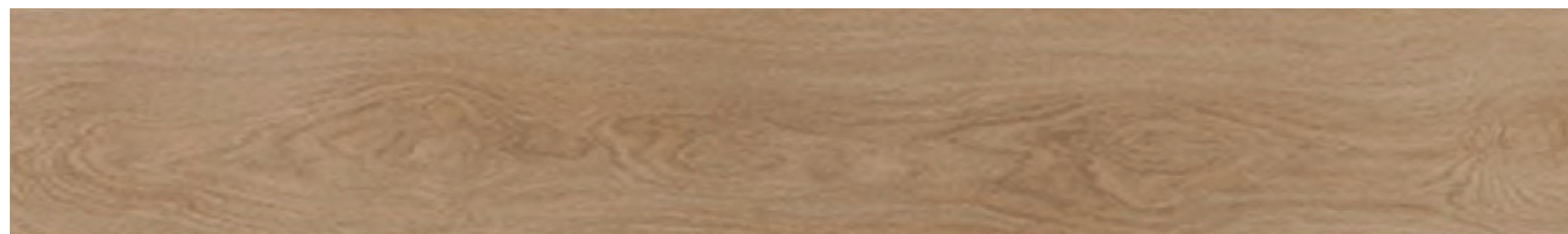

*Porcelain Flooring*

# Writing Center

Writing center  
furniture

Fall 2021 Studio V

Rendering

FR.7

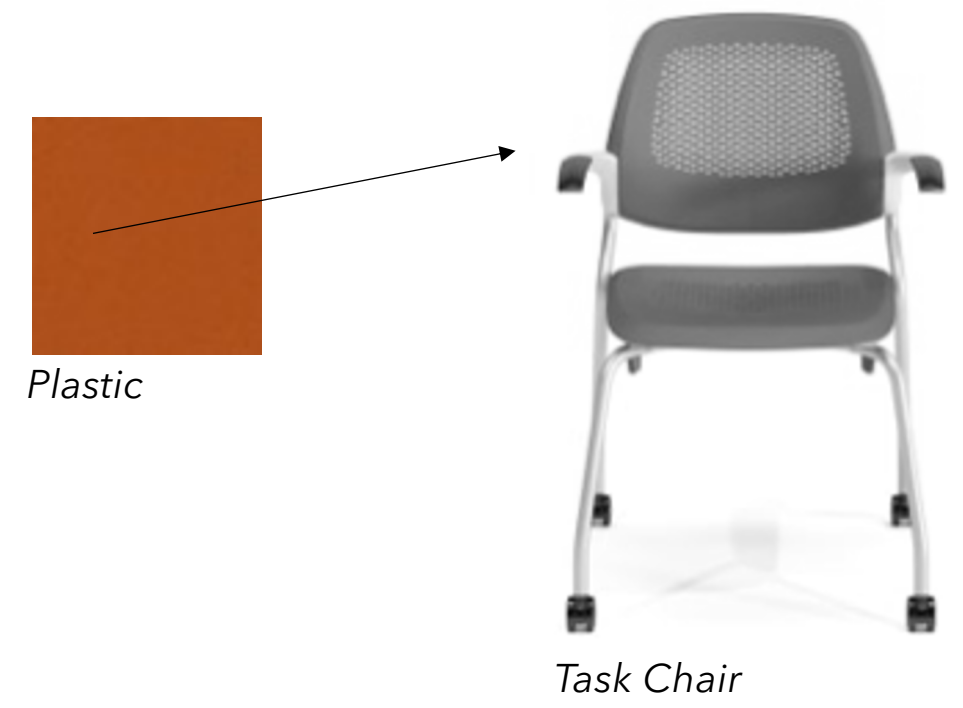
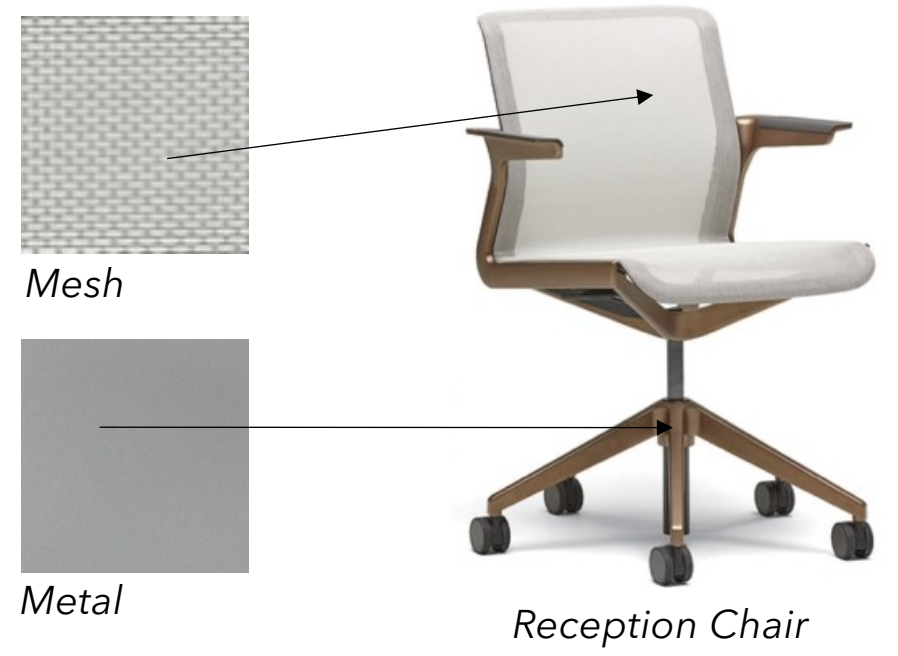
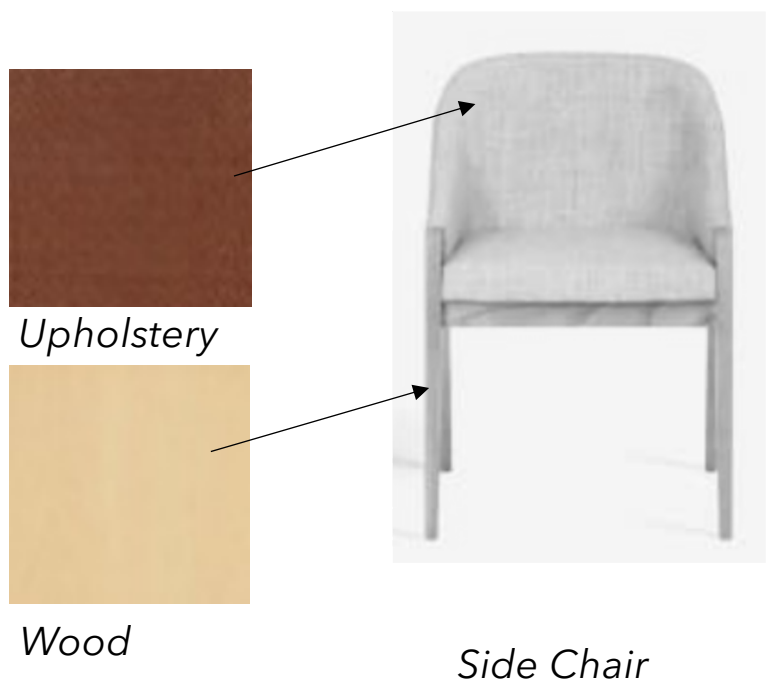
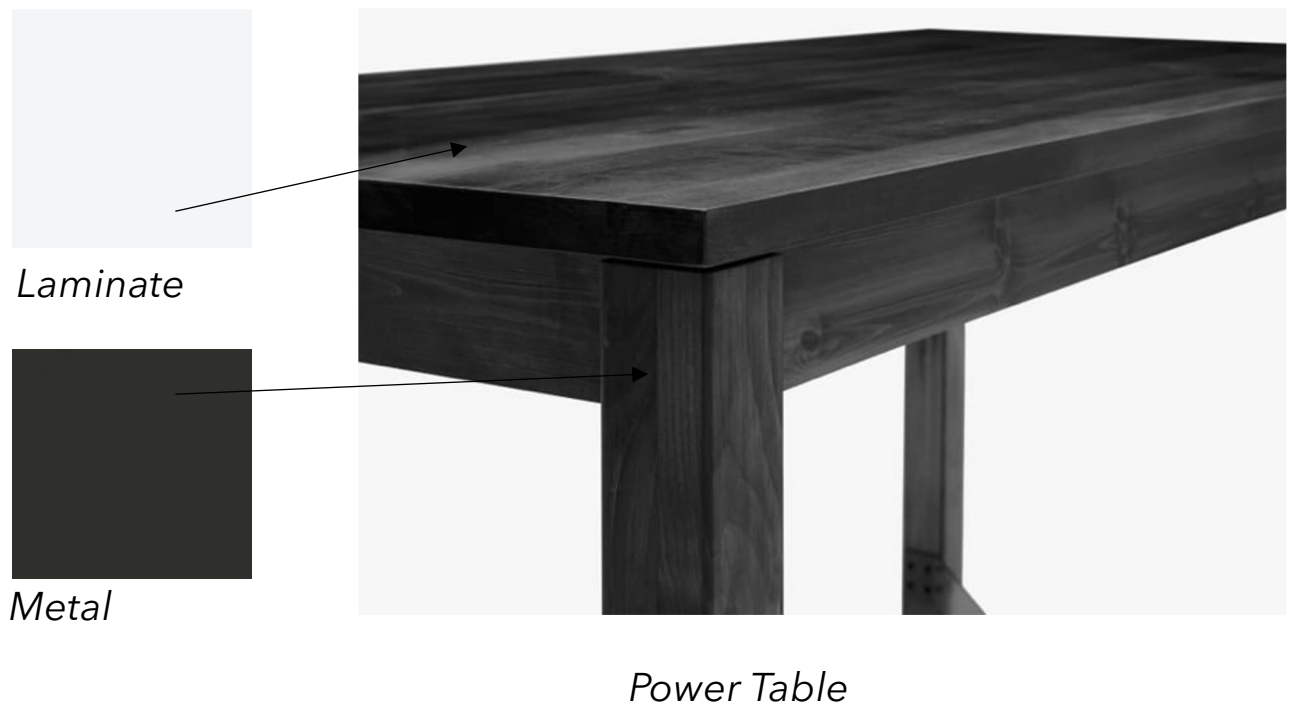
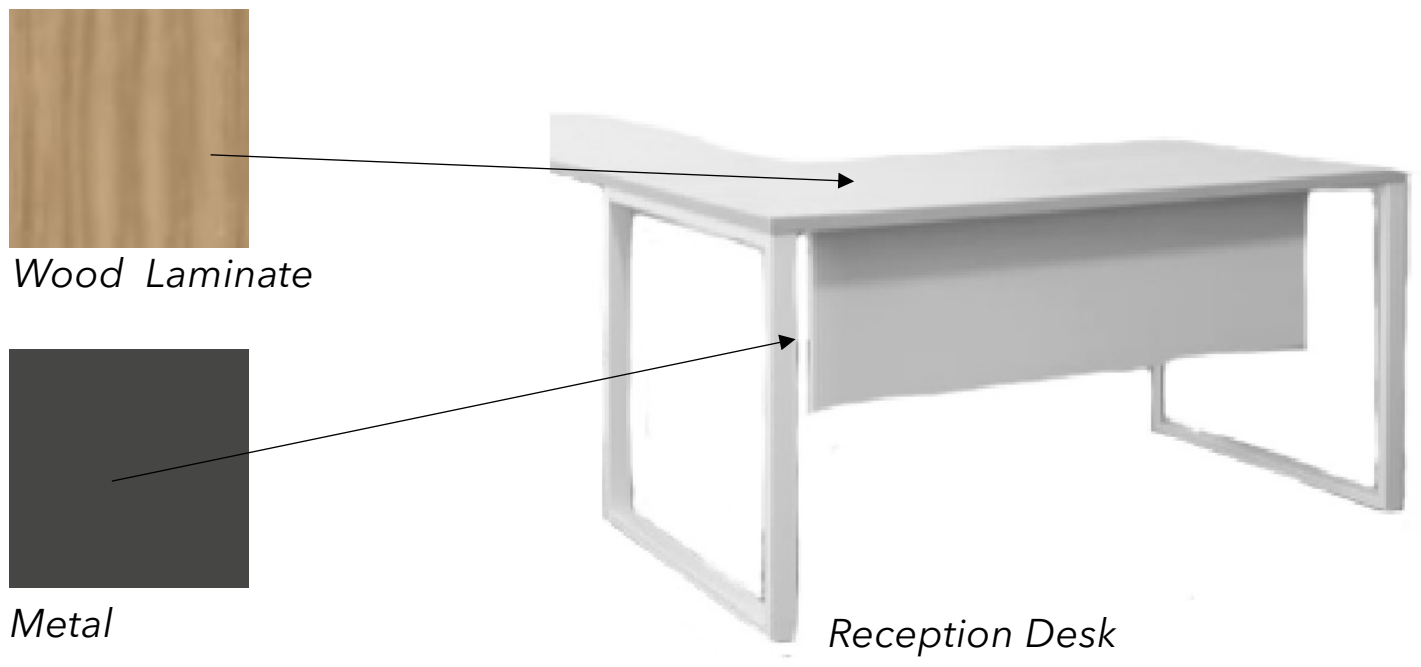

# Office Finishes



*Wall Paint*

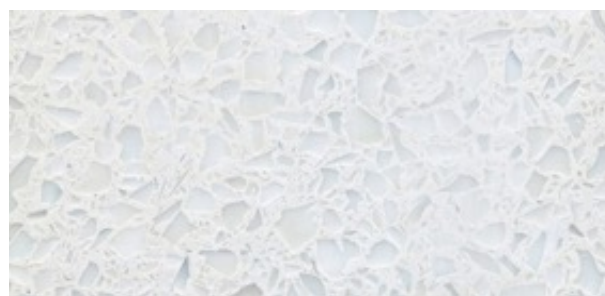

*Terrazzo Countertops*



*Cabinetry*



*Baseboard*



*Porcelain Flooring*

# Offices



Systems Furniture: Office Desk

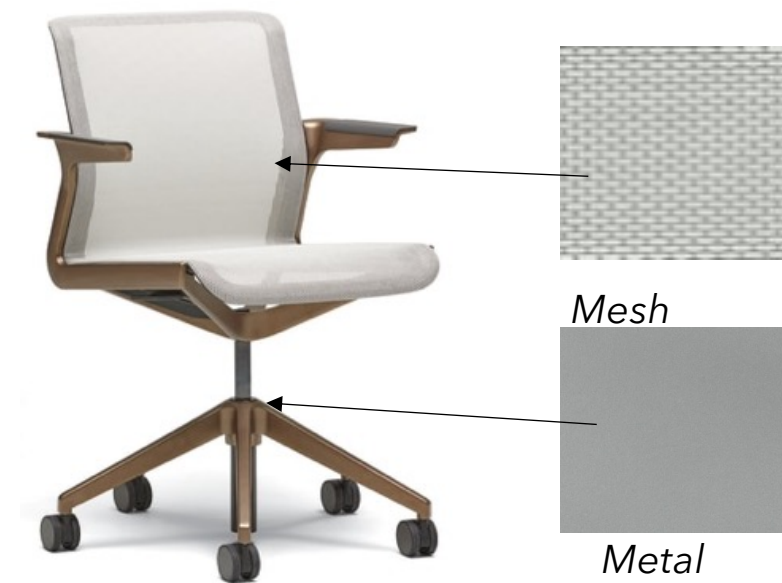

Task Chair



Systems Furniture: Office Credenza

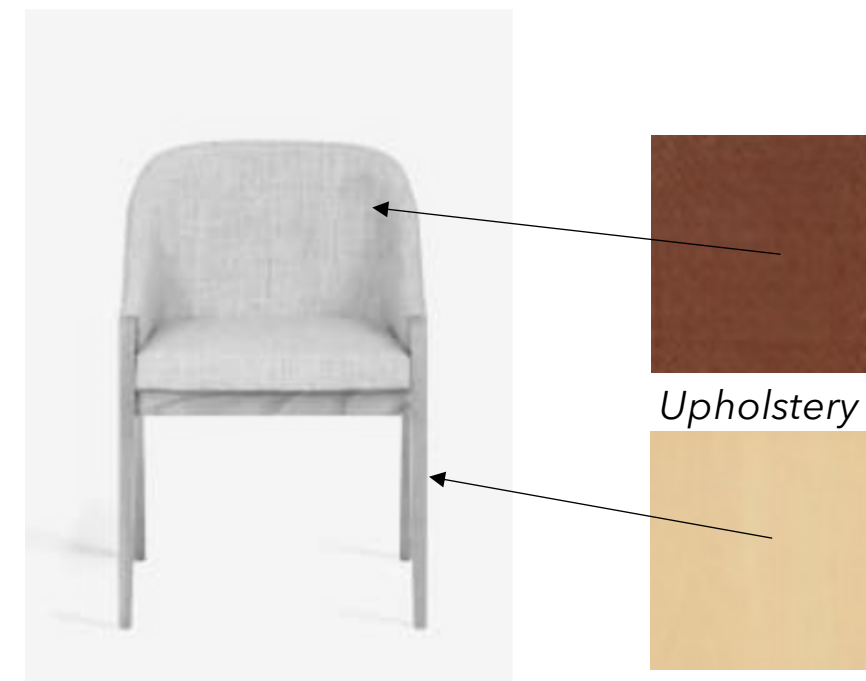

Side Chair



Upper Floor

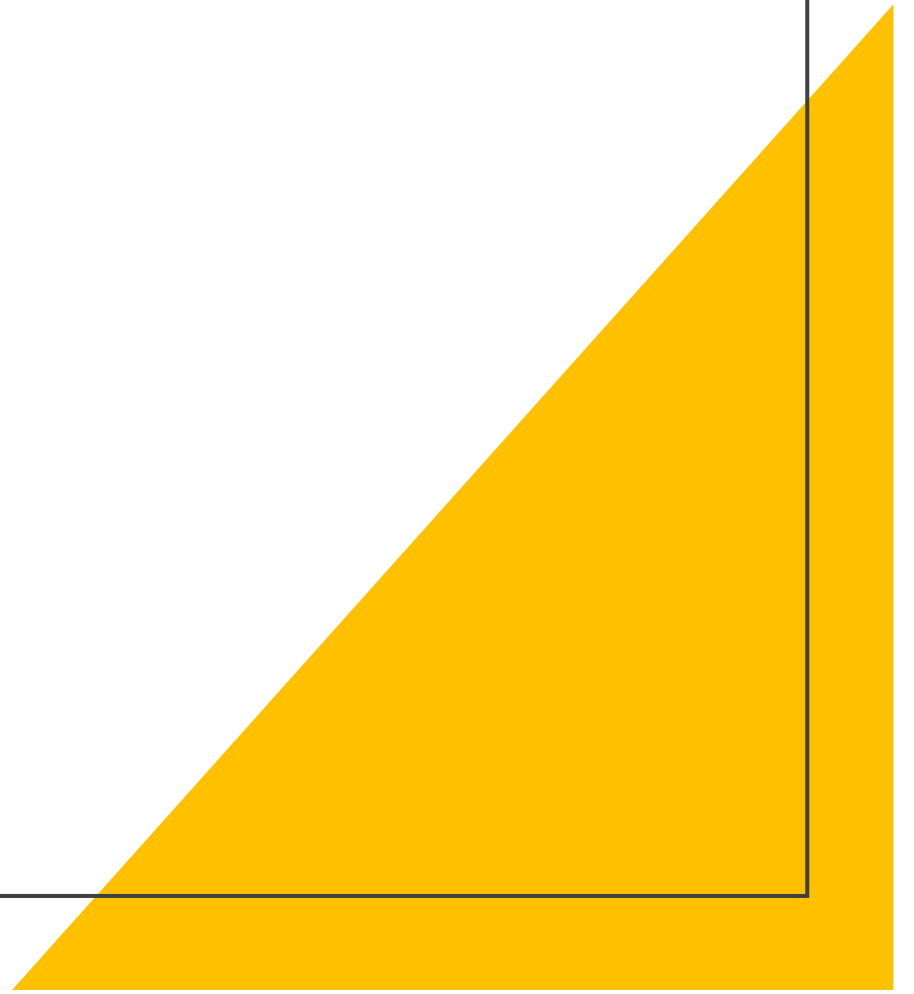

# Furniture Plan

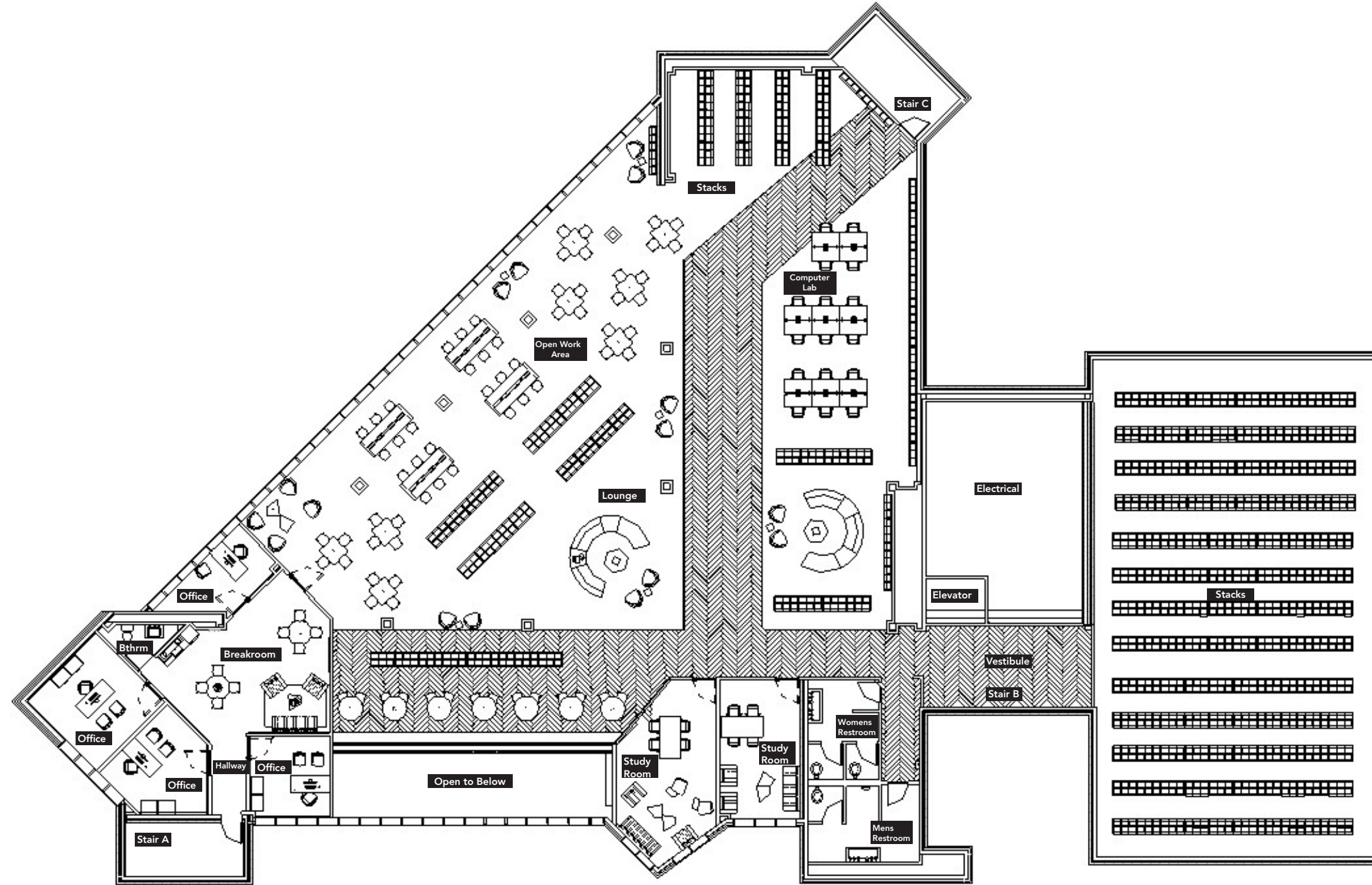

Upper Floor Furniture Plan

Fall 2021 Studio V

Floor Plan

**A5** UPPER FLOOR FURNITURE PLAN

NTS

**A.5**

# Floor Pattern Plan

kw+hr

University of New Haven  
**Marvin K. Peterson Library**

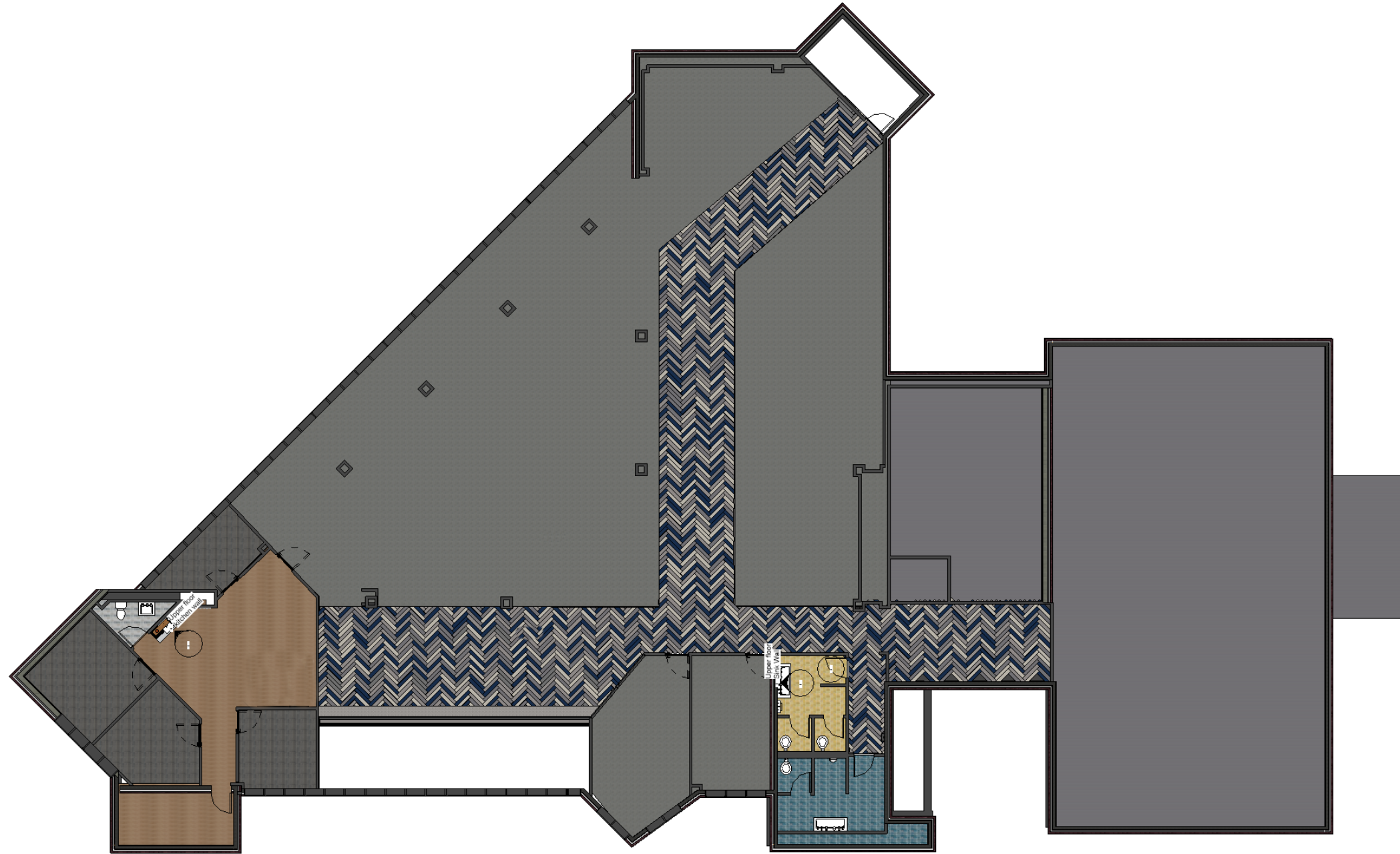

Upper Floor Furniture  
Plan

Fall 2021 Studio V

Floor Plan

A6

UPPER FLOOR PATTERNS PLAN

NTS

A.6

# Lounge Rendering



University of New Haven  
**Marvin K. Peterson Library**

Upper Social Lounge View.

Fall 2021 Studio V

Rendering

P6

UPPER FLOOR SOCIAL LOUNGE PERSPECTIVE

NTS

P.6

# Office Rendering



P7

UPPER FLOOR STAFF BREAKROOM + OFFICES

NTS

kw+hr

University of New Haven  
**Marvin K. Peterson Library**

Upper Floor Office  
Staff lounge view

Fall 2021 Studio V

Rendering

P.7

# Kitchenette Elevation

kw+hr



E1

UPPER FLOOR STAFF BREAK ROOM KITCHEN

NTS

University of New Haven  
**Marvin K. Peterson Library**

Upper Staff Lounge  
Kitchenette Elevation.

Fall 2021 Studio V

Elevation

E.1

# Bathroom Elevations



**E2** UPPER FLOOR PUBLIC WOMENS RESTROOM SINK WALL  
NTS



**E3** MAIN LEVEL STAFF BATH SINK WALL  
NTS

Staff and Public  
Bathroom Elevation.

Fall 2021 Studio V

Elevation

**E.2**

# Bathroom Finishes

## Public Restrooms

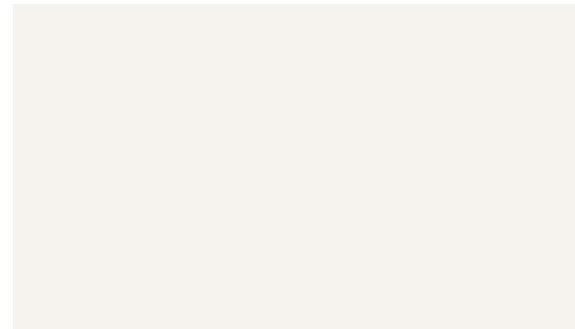

Ceiling Paint

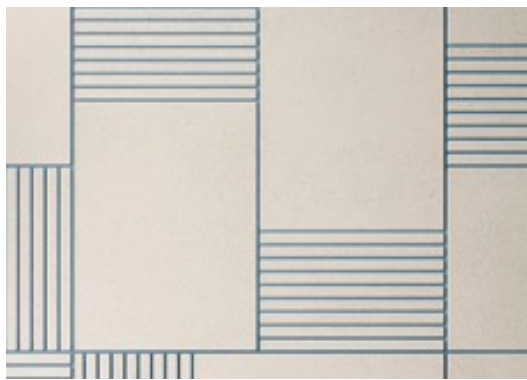

Wall Tile



Partitions

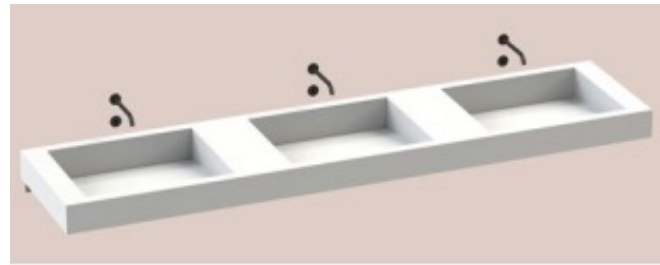

Wall Mounted Sinks

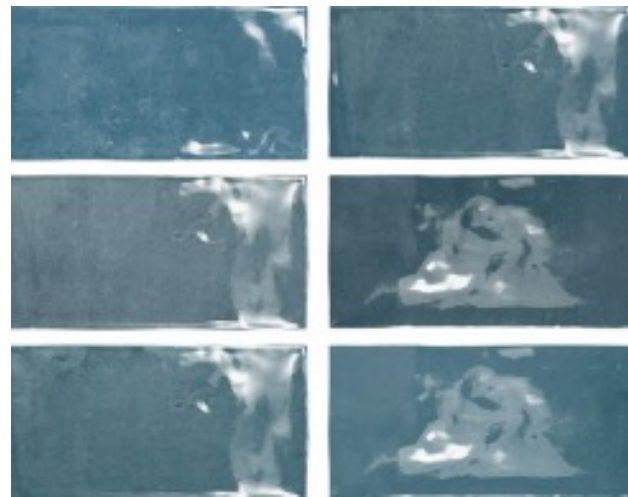

Men's Bathroom Flooring

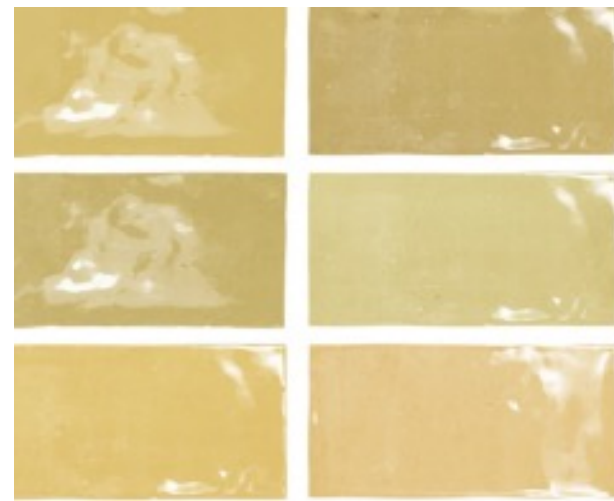

Women's Bathroom Flooring

## Staff Restrooms

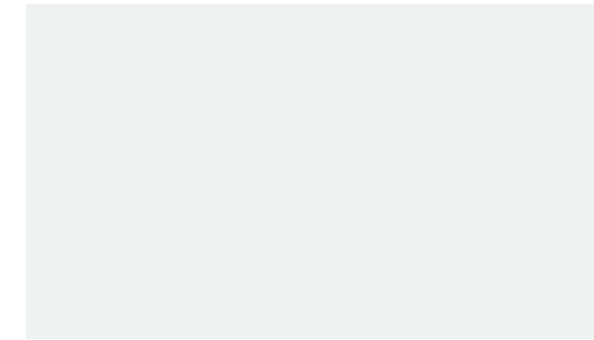

Ceiling Paint

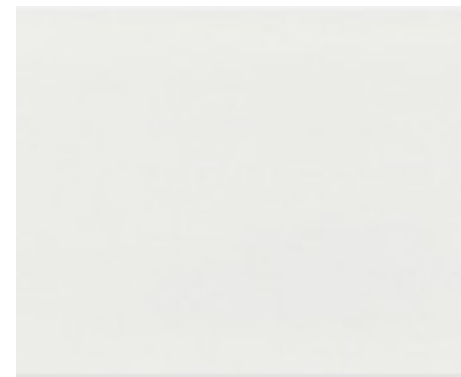

Wall Tile

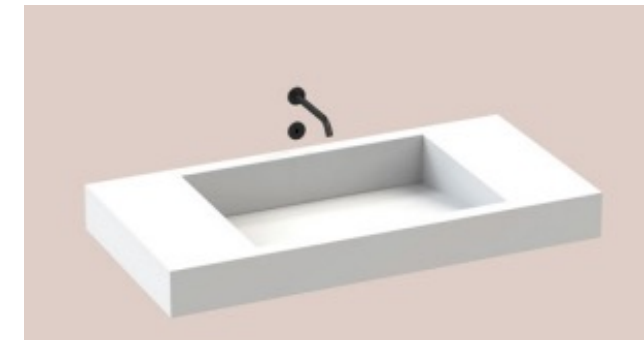

Wall Mounted Sinks

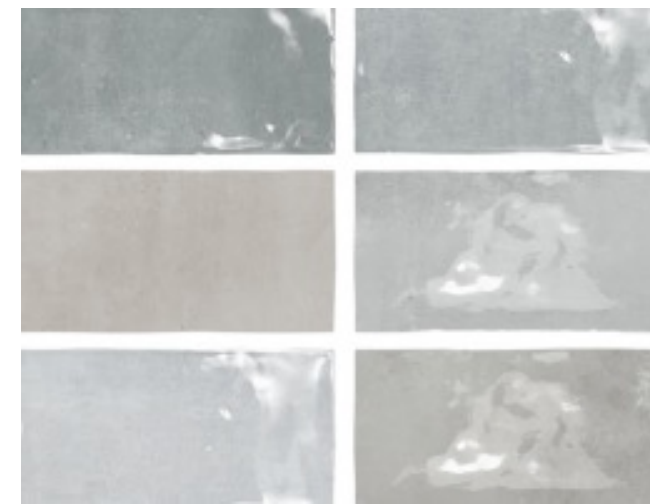

Bathroom Flooring



# Lounge + Open Work Area Finishes

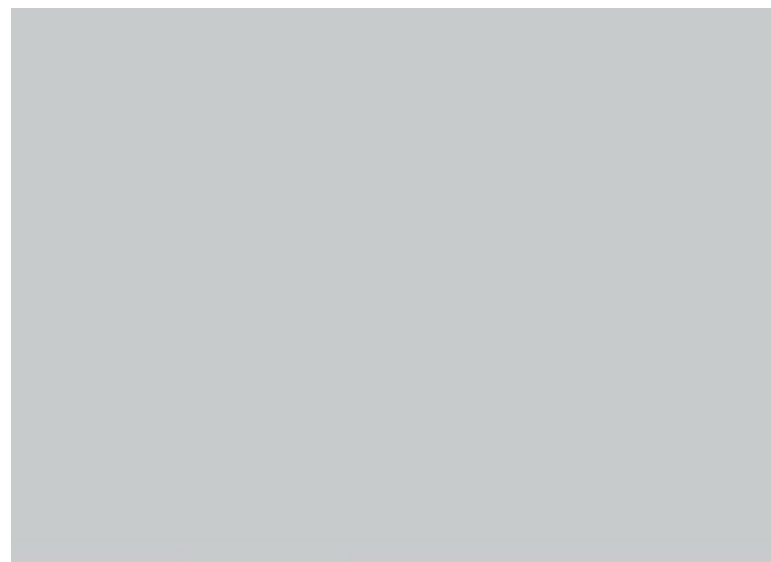

*Wall Paint*



*Baseboard*

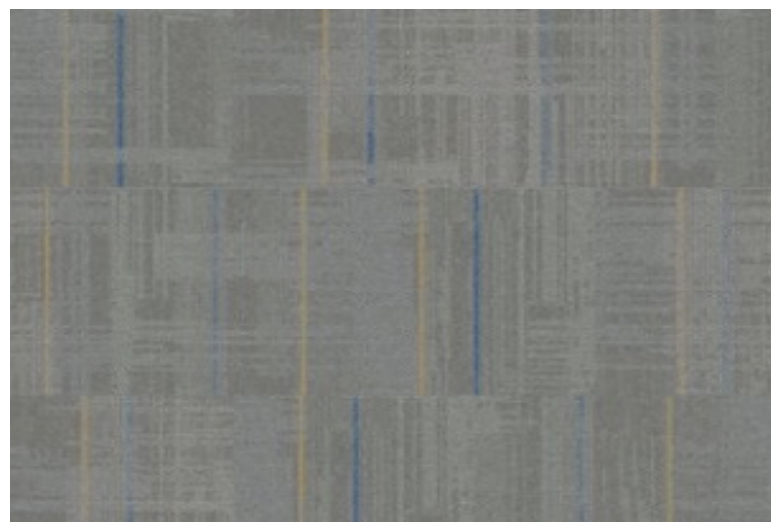

*Carpet Tile*

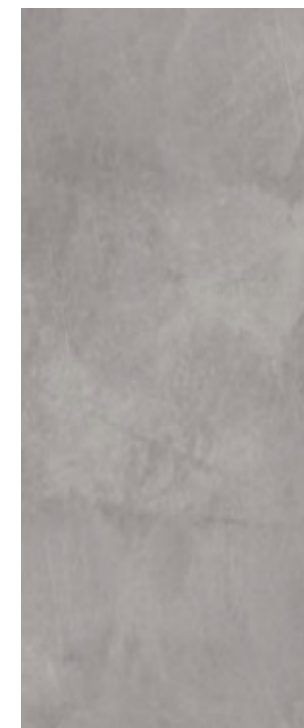
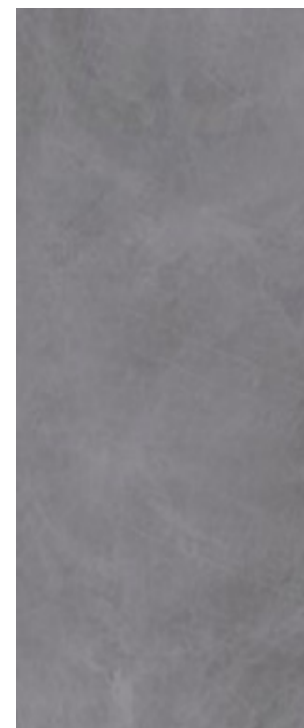
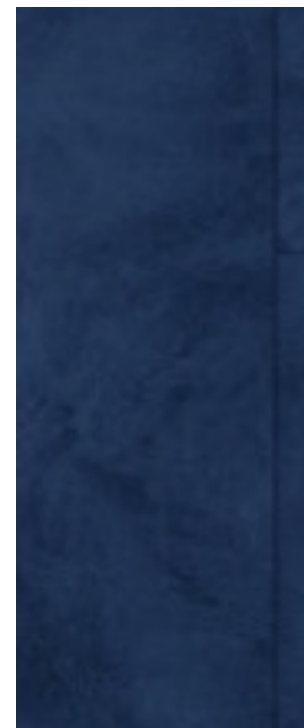

*Herringbone Floor*

# Lounge Area



Upholstery



Modular lounge seating



Side Table



laminata



Power Table



Metal



Coffee Table

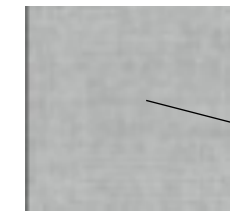

Upholstery

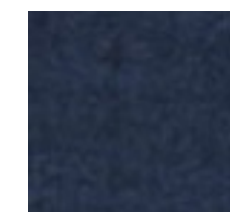

Upholstery

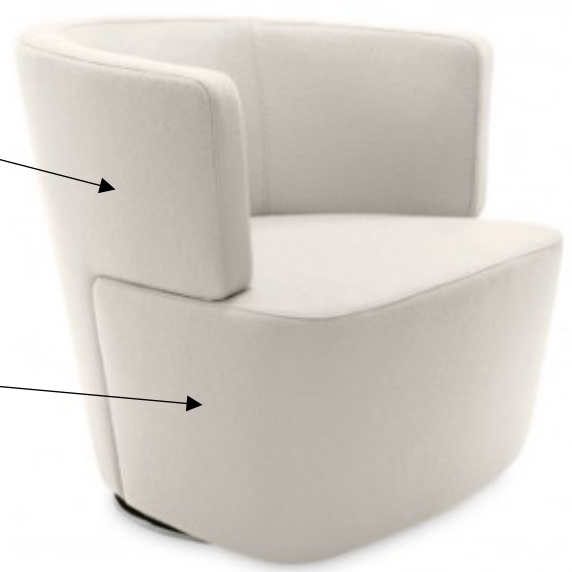

Swivel Chair



Work Chair



Laminata



Laminata

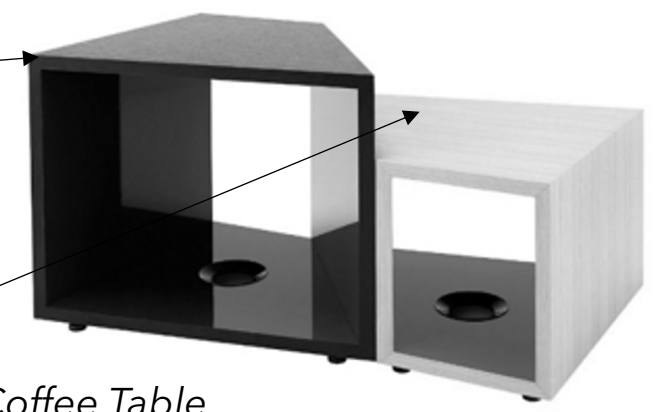

Coffee Table



# Open Work Area



*Collaborative table*

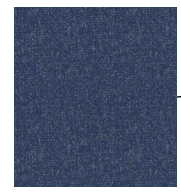

*Felt Upholstery*

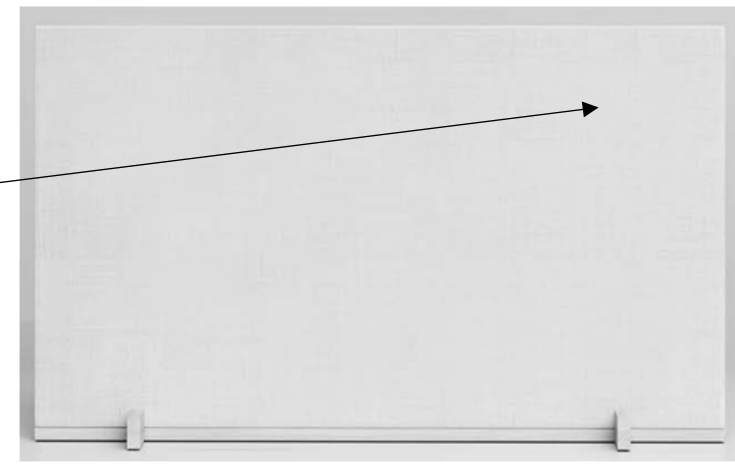

*Acoustics: Table Privacy panel*



*Laminate*



*Power Table*



*Metal*

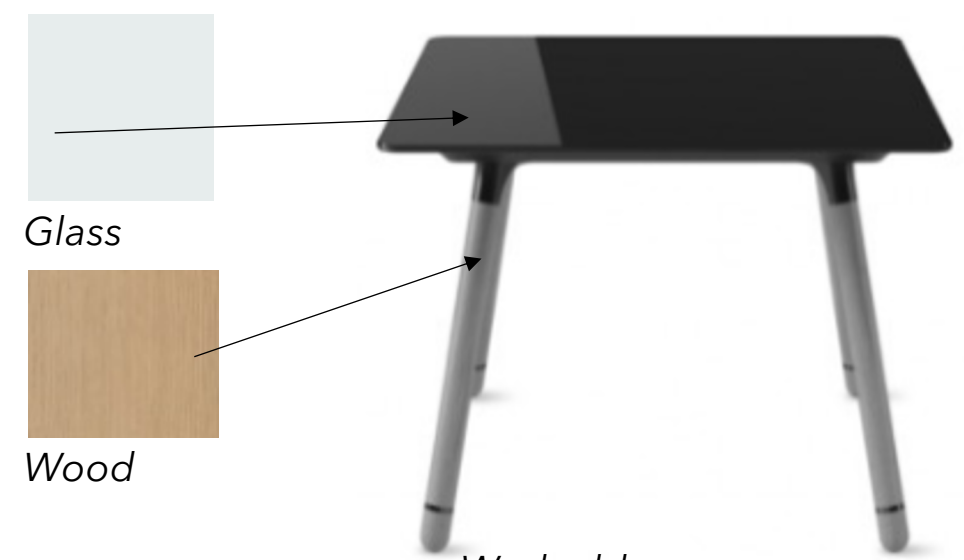

*Worktable*



*Glass*

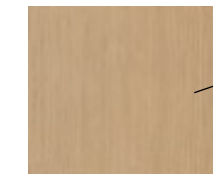

*Wood*

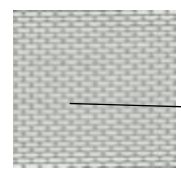

*Mesh*



*Task Chair*

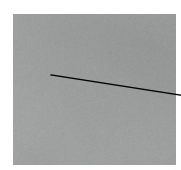

*Metal*



*Work Chair*



# Study Room Finishes



*Wall Paint*



*Baseboard*



*Carpet Tile*

# Study Rooms

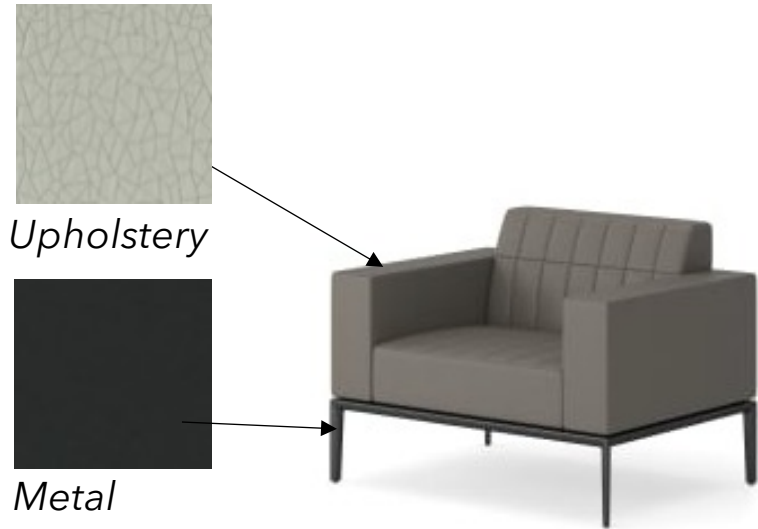

Lounge: Club Chair



Lounge: Armless Sofa

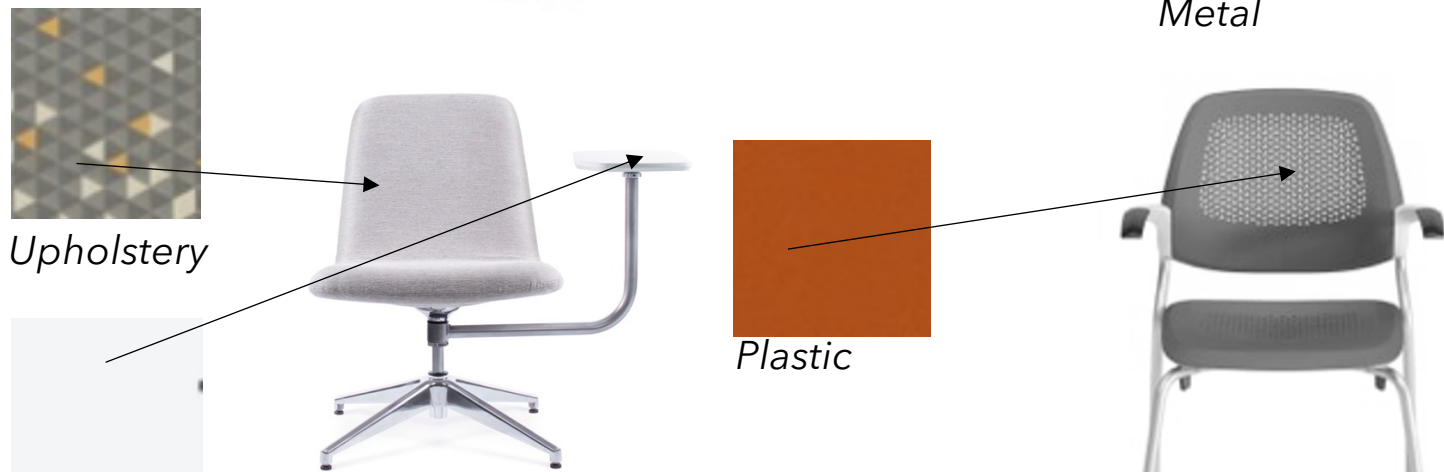

Lounge chair with tablet arm

Task Chair

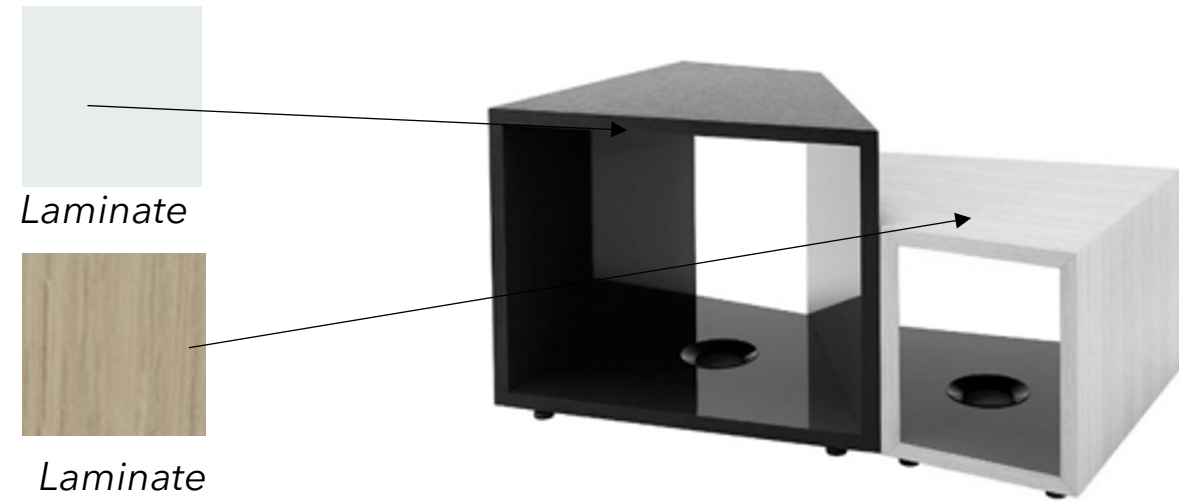

Coffee Table



Power Table

# Office Finishes

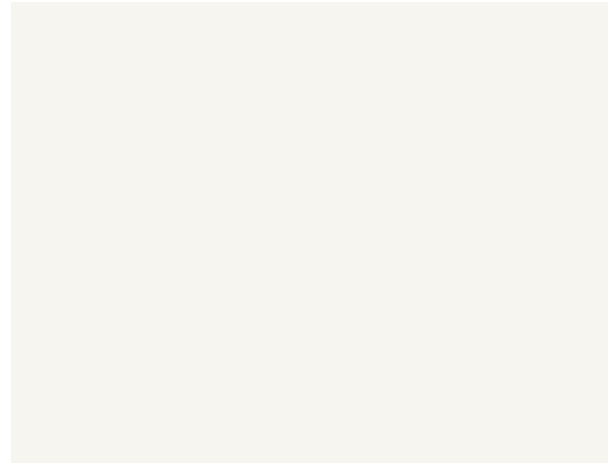

*Wall Paint*



*Baseboard*

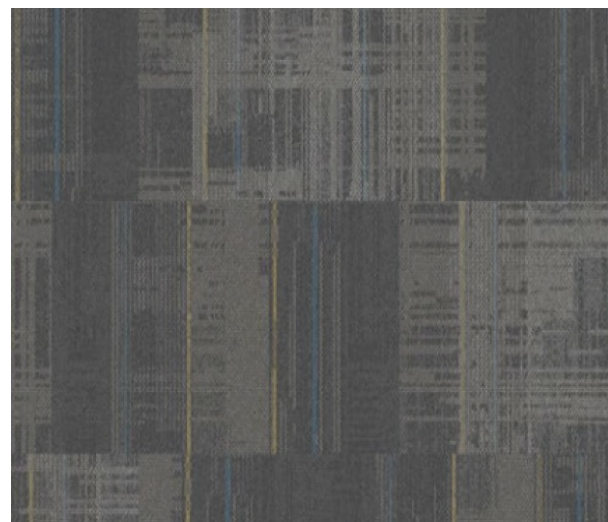

*Carpet Tile*



*Wall Paint*



*Terrazzo Countertops*



*Cabinetry*



*Baseboard*



*Porcelain Flooring*

*Staff Lounge*

# Staff Offices + Lounge

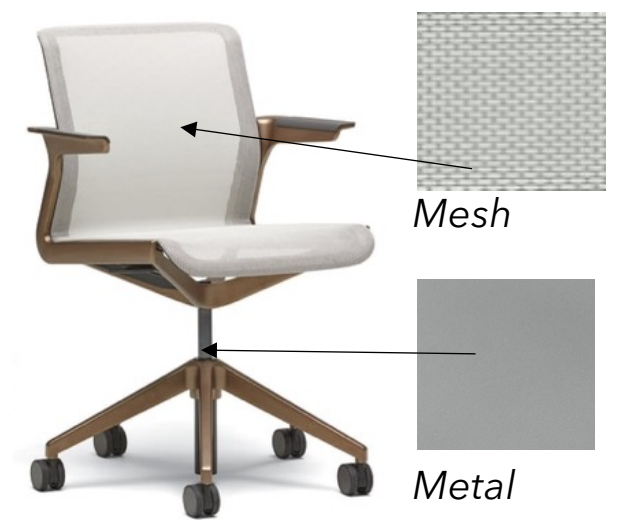

Task Chair

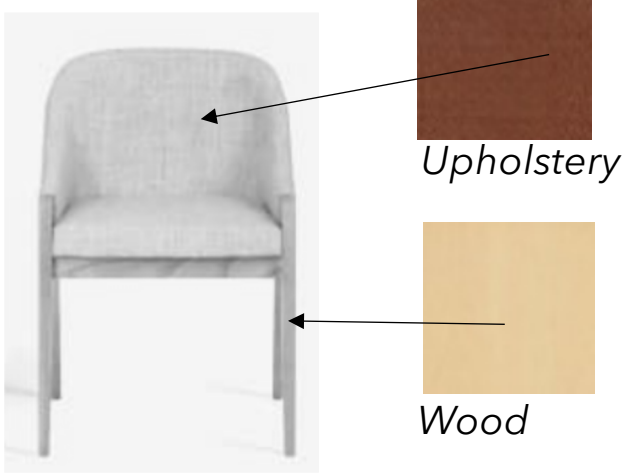

Side Chair

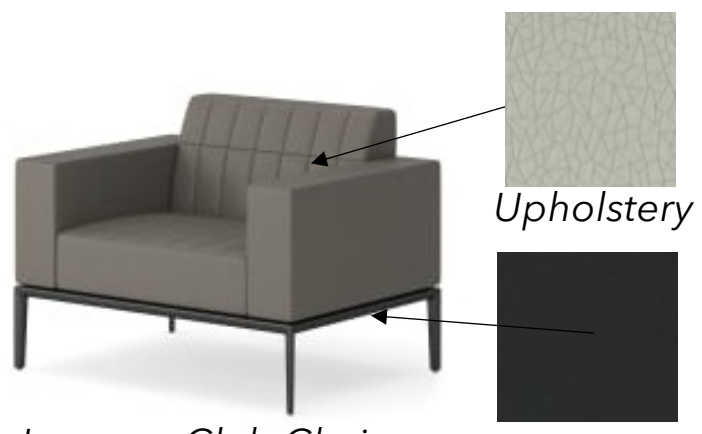

Lounge: Club Chair

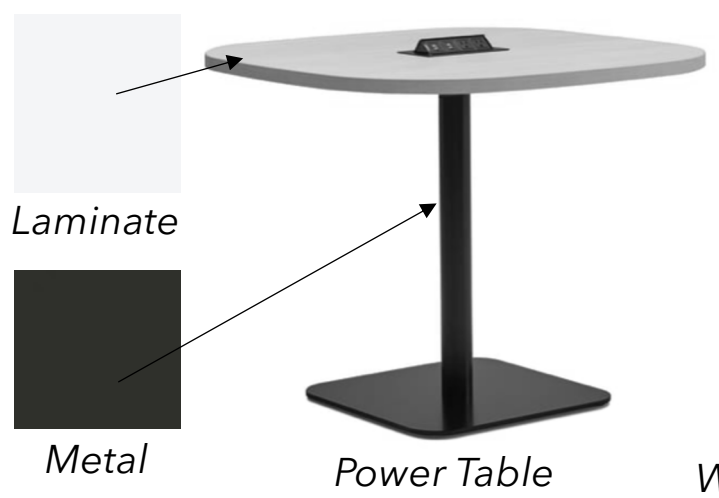

Power Table

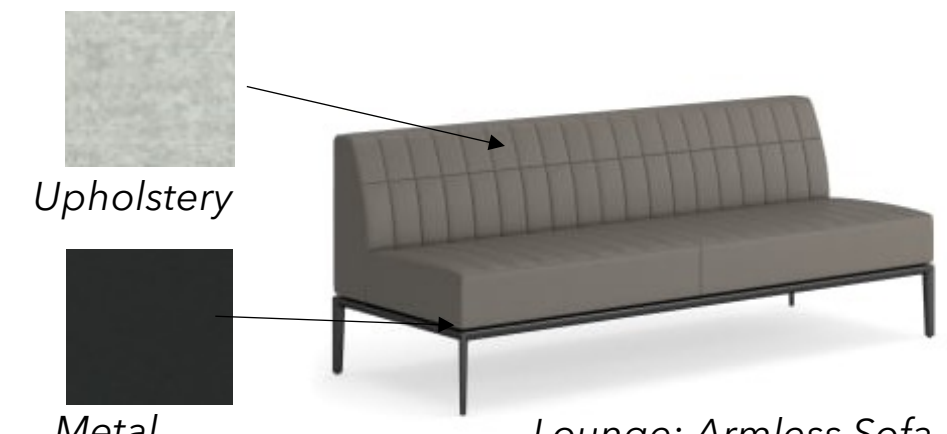

Lounge: Armless Sofa



Systems Furniture: Office Desk



Systems Furniture: Office Credenza



Work Chair

# Rendered Floor Plans

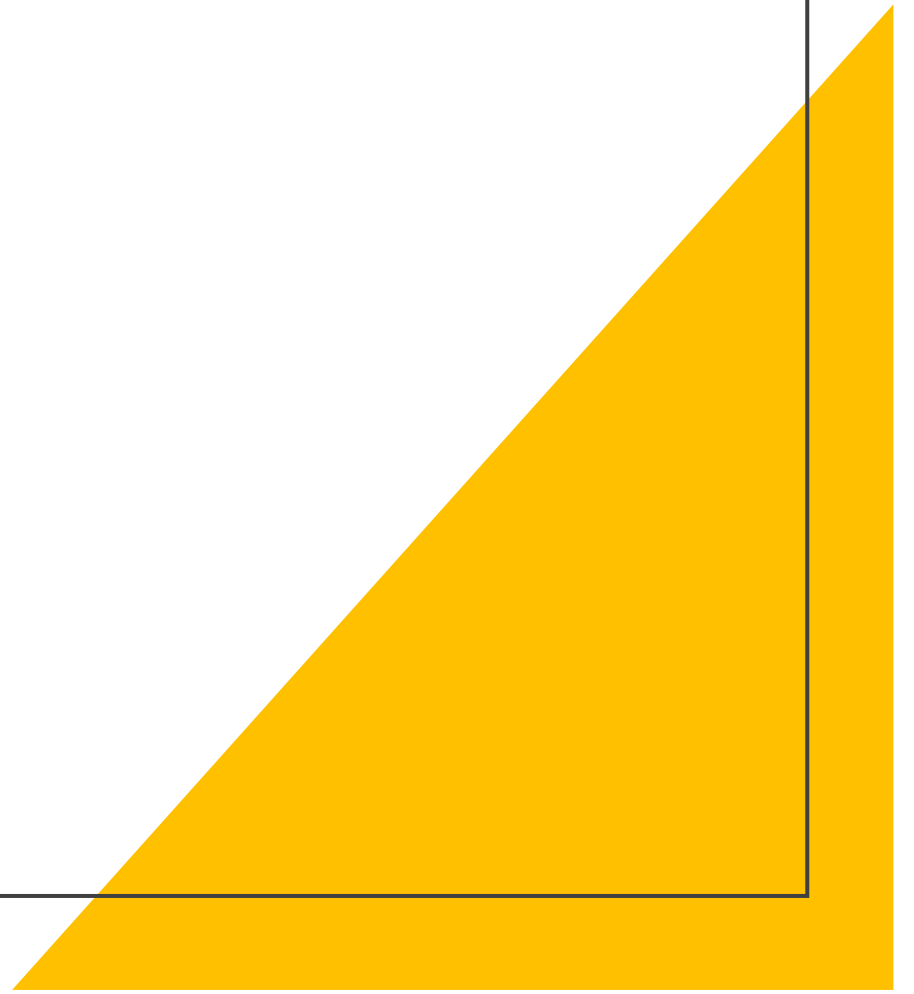



# Lower Level

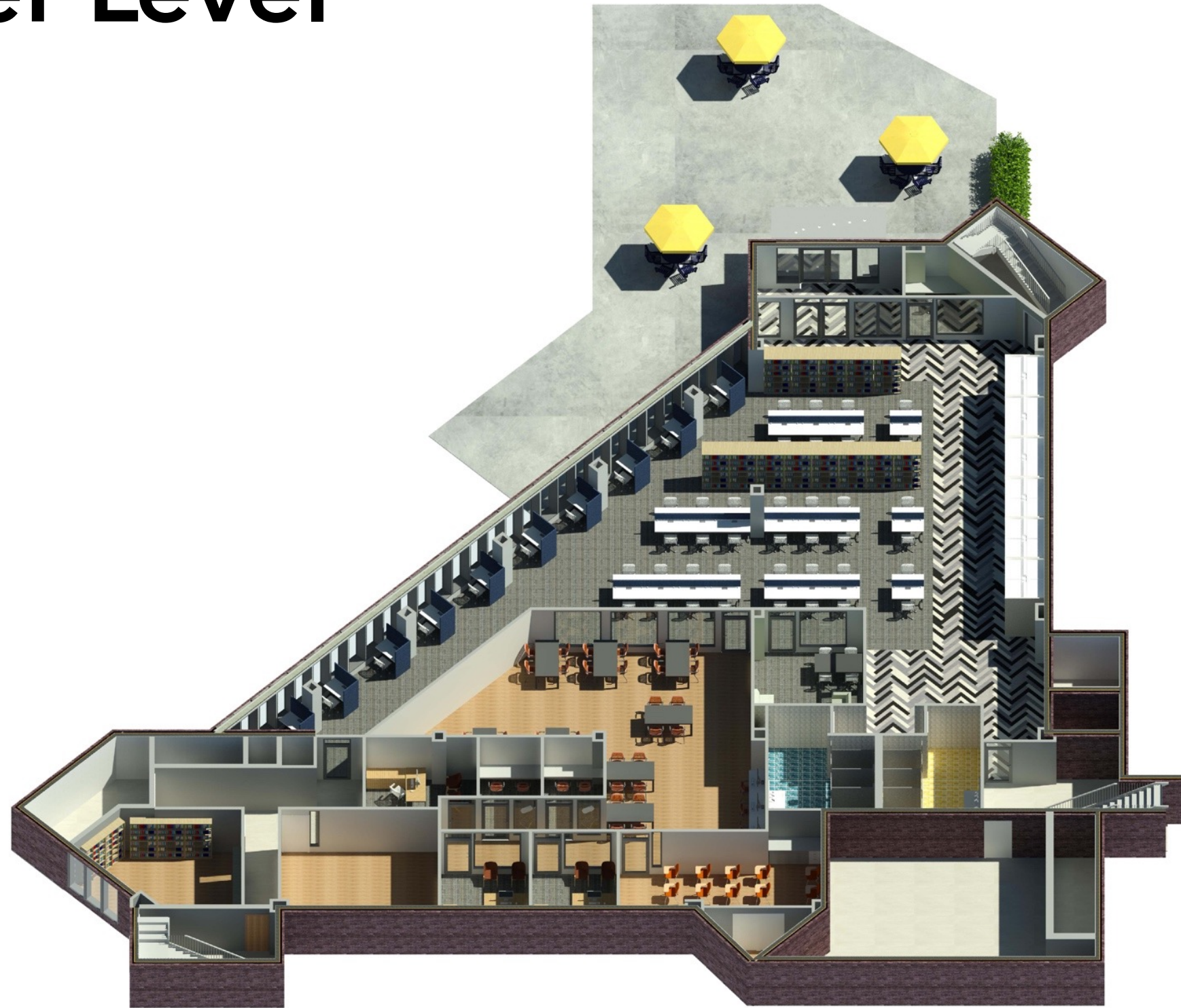

kw+hr

University of New Haven  
**Marvin K. Peterson Library**

Lower Level Rendered  
Furniture Plan

Fall 2021 Studio V

Rendered Floor Plan

# RF.1

# Main Level



kw+hr

University of New Haven  
**Marvin K. Peterson Library**

Main Level Rendered  
Furniture Plan

Fall 2021 Studio V

Rendered Floor Plan

# RF.2

# Upper Floor

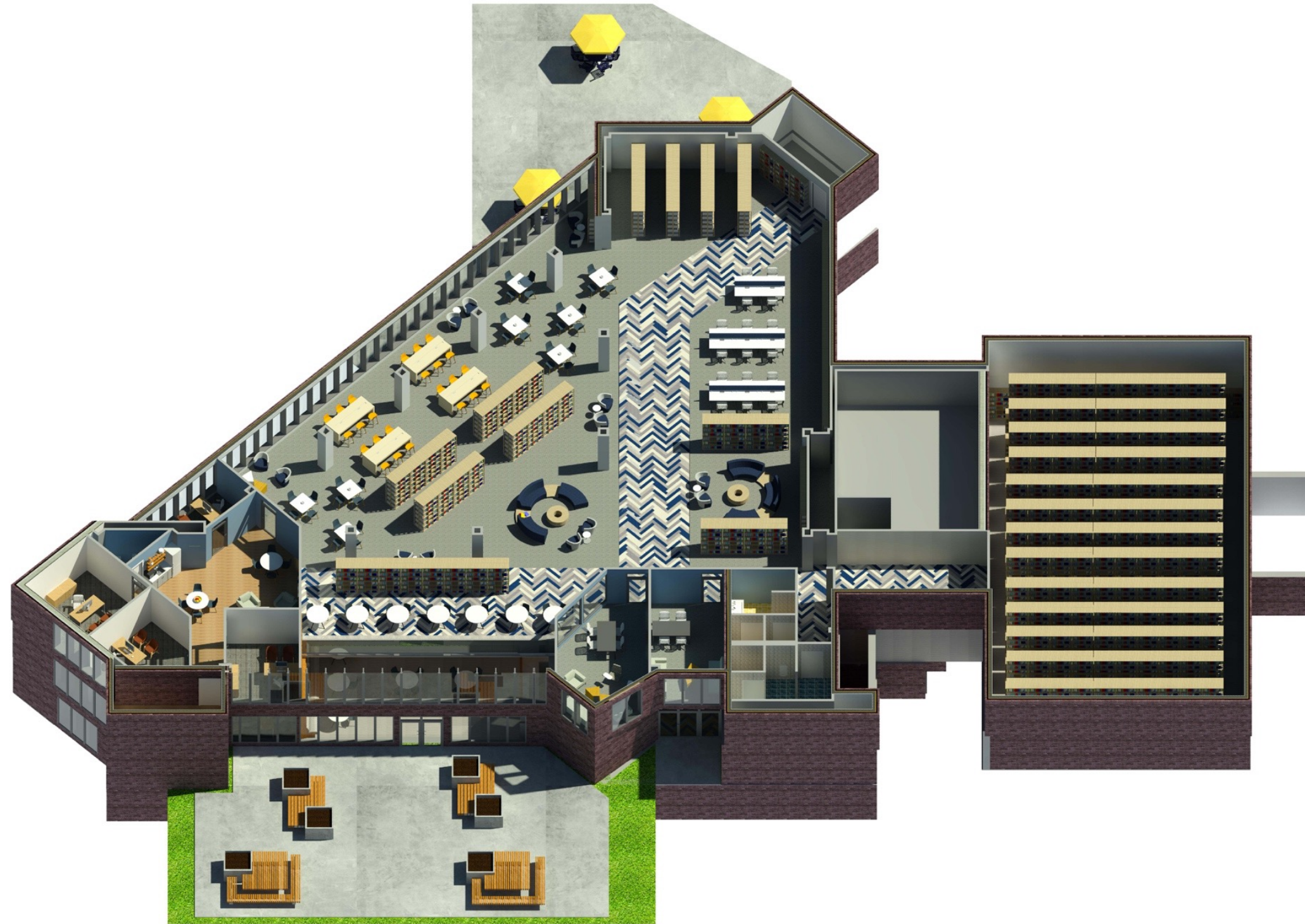

kw+hr

University of New Haven  
**Marvin K. Peterson Library**

Upper Level Rendered  
Furniture Plan

Fall 2021 Studio V

Rendered Floor plan

RF.3